

**BLODGETT**® **BLODGETT**® **BLODGETT**® **BLODGETT**®

**BLODGETT**® **BLODGETT**® **BLODGETT**®

**BLODGETT**® **BLODGETT**® **BLODGETT**® **BLODGETT**®

**BLODGETT**®

**BCX-14G, BCX-14E, BX-14G, BX-14E,  
GAS & ELECTRIC COMBI OVEN/STEAMERS  
INSTALLATION - OPERATION - MAINTENANCE**



**BLODGETT OVEN COMPANY**

[www.blodgett.com](http://www.blodgett.com)

42 Allen Martin Drive, Essex Junction, VT 05452 USA Telephone: (802) 658-6600 Fax: (802) 864-0183

PN 39678 Rev AM (2/19)

© 2019 - G.S. Blodgett Corporation

Your Service Agency's Address:

\_\_\_\_\_

Model

\_\_\_\_\_

Serial number

\_\_\_\_\_

Oven installed by

\_\_\_\_\_

Installation checked by

# IMPORTANT

**WARNING:** Improper installation, adjustment, alternation, service or maintenance can cause property damage, injury or death. Read the installation, operation and maintenance instructions thoroughly before installing or servicing this equipment.

INSTRUCTIONS TO BE FOLLOWED IN THE EVENT THE USER SMELLS GAS MUST BE POSTED IN A PROMINENT LOCATION. This information may be obtained by contacting your local gas supplier.

## FOR YOUR SAFETY

Do not store or use gasoline or other flammable vapors or liquids in the vicinity of this or any other appliance.

The information contained in this manual is important for the proper installation, use, and maintenance of this oven. Adherence to these procedures and instructions will result in satisfactory baking results and long, trouble free service. Please read this manual carefully and retain it for future reference.

**ERRORS:** Descriptive, typographic or pictorial errors are subject to correction. Specifications are subject to change without notice.

# TABLE OF CONTENTS

## INSTALLATION

The Blodgett Combi-Oven/Steamer .....	4
Description of the Combi-Oven/Steamer .....	5
Owner's Responsibilities .....	2
Utility Connections - Standards and Codes .....	4
Oven Location and Ventilation .....	5
Leg Attachment .....	6
Caster Attachment .....	7
Stacking .....	8
Delimiting System Connection and Priming (BCX-14 units only) .....	9
Plumbing Connections .....	12
Electrical Connections .....	13
Gas Connection .....	14
Gas Hose Restraint .....	16
Adjustments .....	17
Final Check Lists .....	18

## OPERATION

Safety Information for Gas Units .....	19
Power Switches .....	20
Standard Controls .....	21
SmartTouch 2 Touchscreen Control .....	25

## MAINTENANCE

Spray Bottle Operating Procedure .....	37
Cleaning and Preventive Maintenance .....	38
Daily Cleaning .....	38
Preventive Maintenance .....	38
Weekly Cleaning - All Models .....	38
BX-14 Boilerless Oven Weekly Cleaning .....	39
Flushing the Boiler - BCX Models Only .....	40
Delimiting .....	41
BCX Combi Ovens .....	41
BX-14 Boilerless Oven .....	43
Delimiting Interval Setting - BCX Only .....	44



# Installation

---

## The Blodgett Combi-Oven/Steamer

The Blodgett Combi-Oven/Steamer offers a completely new method of cooking. With the Oven/Steamer you have the choice of two cooking processes: Steam and Hot Air, either...

- Separately
- Combined, or
- In Sequence

And for easy operation you can choose from three modes:

In the **Steam mode** you can:

steam	reheat	reconstitute
stew	thaw	simmer
blanche	preserve	braise
poach		

In the **Hot Air** mode you can:

roast	bake	grill
gratinat	broil	

In the **Combination Steam and Hot Air** mode you can:

defrost	roast	rethermalize
reheat	bake	forced steam

You can also use two or three functions in sequence during one cooking process. We call this:

- combi-steaming
- combi-roasting
- combi-baking

The combination of circulating hot air and steam in the space saving, high performance Combi-Oven/Steamer leads to improvements in the following areas:

- increased productivity in the kitchen
- a reduction in capital expenditures for multiple equipment replacement
- a wider range of menu choices
- a simplified cleaning process

The work process is simplified since products are prepared on or in steam table pans and trays. Food can be cooked, stored, and transported with the same pans. Small amounts of product can be processed efficiently; pre-cooked and convenience foods can be reheated within minutes. Many frozen foods can be processed without pre-thawing. This flexibility in preparation reduces the need for kettles and steam tables since there is no need for large amounts of food to be kept warm for long periods of time.

Today the improvement of food quality is more important than ever. Vegetables are cooked in the Blodgett Combi-Oven/Steamer without water at the optimal temperature of just under 100°C (21°F), maintaining valuable vitamins, minerals, nutrients and trace elements. Cooking meat in the Combi results in less shrinkage and a firmer, juicier product. The Blodgett Combi-Oven/Steamer is being used more and more for baking. Steam and Hot Air modes make it a general purpose baking appliance.



## Description of the Combi-Oven/Steamer

### ABOUT THE OVEN/STEAMER

Blodgett Combi-Oven/Steamers are quality produced using high-grade stainless steel with first class workmanship.

The multiple speed fan, which is guarded against accidental finger contact, is driven by a quiet and powerful motor. The condenser draws out excess steam from the appliance. Condensation and waste water, which result during steaming and cleaning, are continuously drained.

The use of high quality insulation impedes excessive heat radiation and saves energy.

The Oven/Steamer has optional adjustable legs which adapt easily to slightly uneven surfaces and optional floor stands which are designed for use with all of the table models.

The high performance fresh steam generator with its control system makes it possible to enjoy all of the advantages of a high quality steamer at the flick of a switch. Fresh steam enters the oven cavity without pressure and is circulated at high speed. This process enables quick and gentle cooking and ensures high quality food while providing convenient working methods. The steam generator is completely automatic and protected from running dry.

### OVEN/STEAMER OPERATION

The practical oven door, with a viewing window, has a wide swing radius and handle which can be operated easily, even with wet or greasy hands.

Ease of operation is guaranteed through the simple arrangement of the controls. Graphic symbols make the appliance easy for even inexperienced kitchen staff to operate. The Steam On Demand feature allows the operator to add steam at any time while operating in either the Hot Air or Combi modes. This feature is excellent for baking as well as roasting operations. A fourth function, the Cool Down mode, allows the oven cavity to cool down rapidly with the door opened.

Cleaning is kept to a minimum. The interior is sprayed with a self-acting cleaning solution which interacts with steam to easily remove crusts and stains. The oven is designed for easy care and is welded water tight so that the internal cooking cavity may be rinsed with a hose after the steam cleaning process.



# Installation

## Owner's Responsibilities

### INSTALLATION RESPONSIBILITIES PRIOR TO SERVICE STARTUP INSPECTION

You are entitled to a free start-up inspection service by our factory ASAP. Before a factory representative arrives to perform a startup procedure, the owner must already have satisfied the following requirements.

*NOTE: Please refer to Leg Attachment and Stacking.*

**Maximum shelf loading - 60 lbs (27.3 Kg)**

1. Oven(s) are uncrated, stacked (if applies) and put in place.

PLUMBING SPECIFICATIONS	
<b>WATER</b>	
Water pressure	40 PSI minimum 50 PSI maximum
Water connection	3/4" garden hose - Hot and Cold water
Minimum requirements	TDS: 40-125 ppm Hardness: 35-100 ppm Chlorides: <25 ppm Silica: <13 ppm Chlorine: <0.2 ppm Chloramine: <0.2 ppm pH: 7.0-8.5
<b>DRAINAGE</b>	
Drain type	Atmospheric Vented Drain
Drain connection	2.00" (50.8mm) Copper
Maximum water drain temperature	140°F (60°C)

# Installation



## Owner's Responsibilities

### ELECTRICAL RATINGS - GAS OVENS - BCX-14G/AA, BX-14G/AA

TYPE OF GAS	GAS INPUT	VOLTAGE	PHASE	AMPS	MOTOR
<b>BCX-14G/AA</b>					
Natural	Steam - 50,000 BTU/Hr	115	1	12	3/4 HP 208-240VAC, 3 phase, 50/60 Hz
	Hot Air - 65,000 BTU/Hr	208-240	1	6	
	Total - 115,000 BTU/Hr				
Propane	Steam - 48,000 BTU/Hr	115	1	12	3/4 HP 208-240VAC, 3 phase, 50/60 Hz
	Hot Air - 65,000 BTU/Hr	208-240	1	6	
	Total - 113,000 BTU/Hr				
<b>BX-14G/AA</b>					
Natural	Hot Air - 65,000 BTU/Hr	115	1	12	3/4 HP 208-240VAC, 3 phase, 50/60 Hz
		208-240	1	6	
Propane	Hot Air - 65,000 BTU/Hr	115	1	12	3/4 HP 208-240VAC, 3 phase, 50/60 Hz
		208-240	1	6	

*3/4" NPT connector for all U.S. and Canadian installations*

### RATINGS - ELECTRIC APPLIANCES - BCX-14E/AA & BX-14E/AA

VOLTAGE	HZ	KW	PHASE	MAX LOAD (AMPS)			MOTOR
				L1	L2	L2	
208	60	19	3	53	53	50	3/4 HP 208-240VAC, 50/60 Hz
240	60	19	3	46	46	43	3/4 HP 208-240VAC, 50/60 Hz
480	60	19	3	23	23	21	3/4 HP 208-240VAC, 50/60 Hz



# Installation

---

## Utility Connections - Standards and Codes

THE INSTALLATION INSTRUCTIONS CONTAINED HEREIN ARE FOR THE USE OF QUALIFIED INSTALLATION AND SERVICE PERSONNEL ONLY. INSTALLATION OR SERVICE BY OTHER THAN QUALIFIED PERSONNEL MAY RESULT IN DAMAGE TO THE OVEN AND/OR INJURY TO THE OPERATOR.

Qualified installation personnel are individuals, a firm, a corporation, or a company which either in person or through a representative are engaged in, and are responsible for:

- The installation or replacement of gas piping. The connection, installation, repair or servicing of equipment.
- The installation of electrical wiring from the electric meter, main control box or service outlet to the electric appliance.

Qualified installation personnel must be experienced in such work, be familiar with all precautions required and have complied with all requirements of state or local authorities having jurisdiction.

### U.S. and Canadian Installations

Installation must conform with local codes, or in the absence of local codes, with the National Fuel Gas Code, NFPA54/ANSI Z223.1-Latest Edition, the Natural Gas Installation Code CAN/CGA-B149.1 or the Propane Installation Code, CAN/CGA-B149.2 as applicable.

Reference: National Electrical Code, ANSI/NFPA 70-Latest Edition and/or Canadian Electrical Code CSA C22.1 as applicable.

This equipment is to be installed in compliance with the Basic Plumbing Code of the Building Officials and Code Administrators International Inc. (BOCA) and the Food Service Sanitation Manual of the Food and Drug Administration (FDA).

Appliance is to be installed with backflow prevention in accordance with applicable federal, province and local codes.

### General Export Installations

Installation must conform with Local and National installation standards. Local installation codes and/or requirements may vary. If you have any questions regarding the proper installation and/or operation of your appliance, please contact your local distributor. If you do not have a local distributor, please call Blodgett Combi at 0011-802-658-6600.





## Oven Location and Ventilation

### OVEN LOCATION

The well planned and proper placement of your oven will result in long term operator convenience and satisfactory performance.

Certain minimum clearances must be maintained between the oven and any combustible or non-combustible construction. See the table below.

In addition, the following clearances are recommended for servicing.

- Oven body sides - 12" (30cm)
- Oven body back - 12" (30cm)

*NOTE: On gas models, routine servicing can usually be accomplished within the limited movement provided by the gas hose restraint. If the oven needs to be moved further from the wall, the gas must first be turned off and disconnected from the oven before removing the restraint. Reconnect the restraint after the oven has been returned to its normal position.*

### Left Side Heat Shield

Heat sources should not be near the air vents located on the left hand side of the gas appliance.

OVEN MODEL	MINIMUM REQUIRED CLEARANCES		
	Right Side	Left Side	Back
BCX-14G	1" (25.4mm)	6" (152.4mm)	6" (152.4mm)
BX-14G	1" (25.4mm)	0" (0mm)	6" (152.4mm)
BCX-14E	2" (50.8mm)	2" (50.8mm)	3" (76.2mm)
BX-14E			

- Do not place strong sources of heat such as open flame ranges, griddles, or charbroilers near the oven. If such an instance exists, it is highly recommended to purchase a heat shield, available from Blodgett.
- Note that if temperatures are too high, a safety shutdown may occur.
- Failure to comply may invalidate the oven warranty.

### VENTILATION

The necessity for a properly designed and installed ventilation system cannot be over emphasized. The ventilation system will allow the unit to function properly while removing unwanted vapors and products of combustion from the operating area.

The appliance must be vented with a properly designed mechanically driven exhaust hood. The hood should be sized to completely cover the equipment plus an overhang of at least 6" (15 cm) on all sides not adjacent to a wall. The capacity of the hood should be sized appropriately and provisions made for adequate makeup air.



### WARNING!!

**Failure to properly vent the oven can be hazardous to the health of the operator; and will result in operational problems, unsatisfactory baking, and possible damage to the equipment. Damage sustained as a direct result of improper ventilation will not be covered by the Manufacturer's warranty.**

When installed in the Commonwealth of Massachusetts, this appliance must be interlocked with the hood exhaust system so that the appliance may be operated only when the hood exhaust system is running.

### U.S. and Canadian Installations

Refer to your local ventilation codes. In the absence of local codes, refer to the National ventilation code titled, "Standard for the Installation of Equipment for the Removal of Smoke and Grease Laden Vapors from Commercial Cooking Equipment", NFPA-96- Latest Edition.

### General Export Installations

Installation must conform with Local and National installation standards. Local installation codes and/or requirements may vary. If you have any questions regarding the proper installation and/or operation of your unit, please contact your local distributor. If you do not have a local distributor, please call Blodgett Combi at 0011-802-658-6600.



# Installation

## Leg Attachment

### LEG OPTIONS

Legs are available in 4" (101mm), 6" (152mm) or 25" (635mm) lengths or low profile casters.

- The 4" (101mm) legs may be used when mounting on a counter.
- The 6" (152.4mm) legs are used on the lower section of a double stacked appliance.
- The 25" (635mm) legs are used for a single appliance located on the floor.

*NOTE: For safety reasons, casters must not be used with the 25" (635mm) legs.*

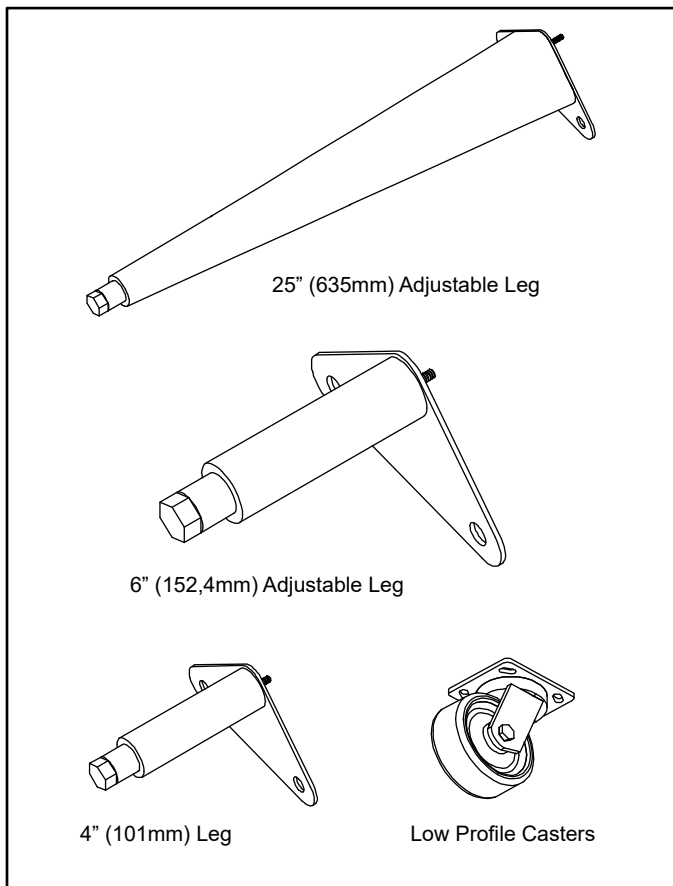

Figure 1

### ATTACHMENT

1. Align the threaded stud on one of the front legs to the bolt hole located in the bottom corner of the appliance. Turn the leg clockwise and tighten to the nearest full turn.
2. Align the leg plate holes with the bolt holes. Secure with the two 1/2" bolts provided.
3. Repeat the above steps with the other front leg. If low profile casters are used, install them with the locking casters in the front of the oven. The rear casters do not lock. **Ensure that the locks are set on the front casters.**
4. Tip the oven up on the newly installed front legs. If casters are used, check that the locks are set on the front casters. Repeat the above steps for the rear legs.
5. Level the oven by screwing the adjustable feet in or out as necessary.

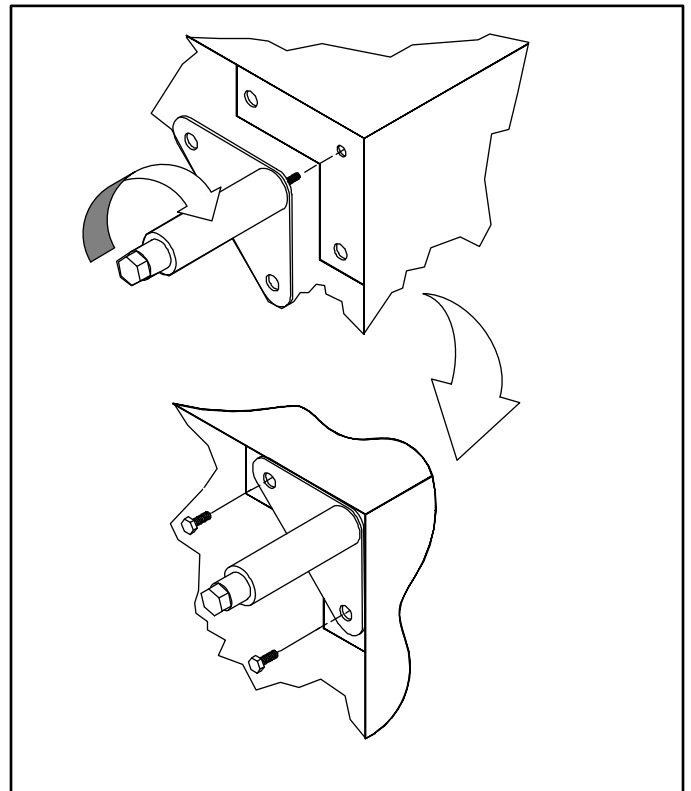

Figure 2

## Caster Attachment

1. Place a level on the floor where the casters are to rest.
2. Place shims under the low side until it is level.
3. Mount the shims between the casters and the oven as follows:
  - a. Align the shims and caster holes with the bolt holes.
  - b. Secure with the 1/2" bolts provided.

*NOTE: Install them with the locking casters in the front of the oven. The rear casters do not lock. Ensure that the locks are set on the front casters.*

4. Tip the oven up on the newly installed casters.

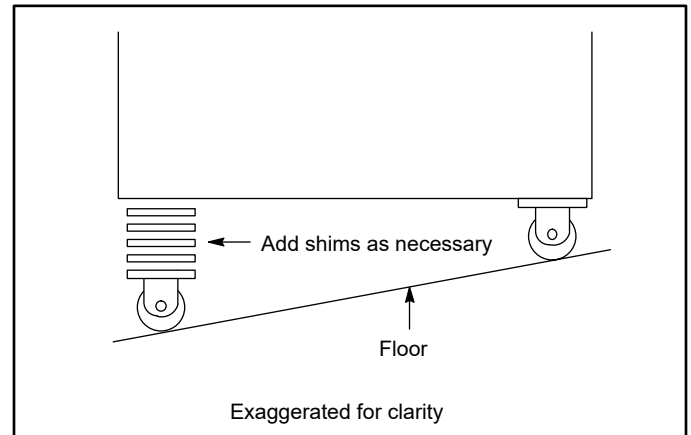

**Figure 3**



# Installation

## Stacking



### WARNING!!

Stacking should be performed by qualified installation personnel only. The ovens are heavy. Take care to use proper tools and techniques when lifting and stacking units.

1. Attach the legs or casters to the bottom oven.
2. Place the top oven on the bottom oven. Be sure all four sides are flush.
3. Remove left side oven panels.
4. Bolt the two ovens together from underneath into the two threaded nut retainers.
5. **GAS APPLIANCES ONLY:** Attach the flue vents and gas manifold as shown.

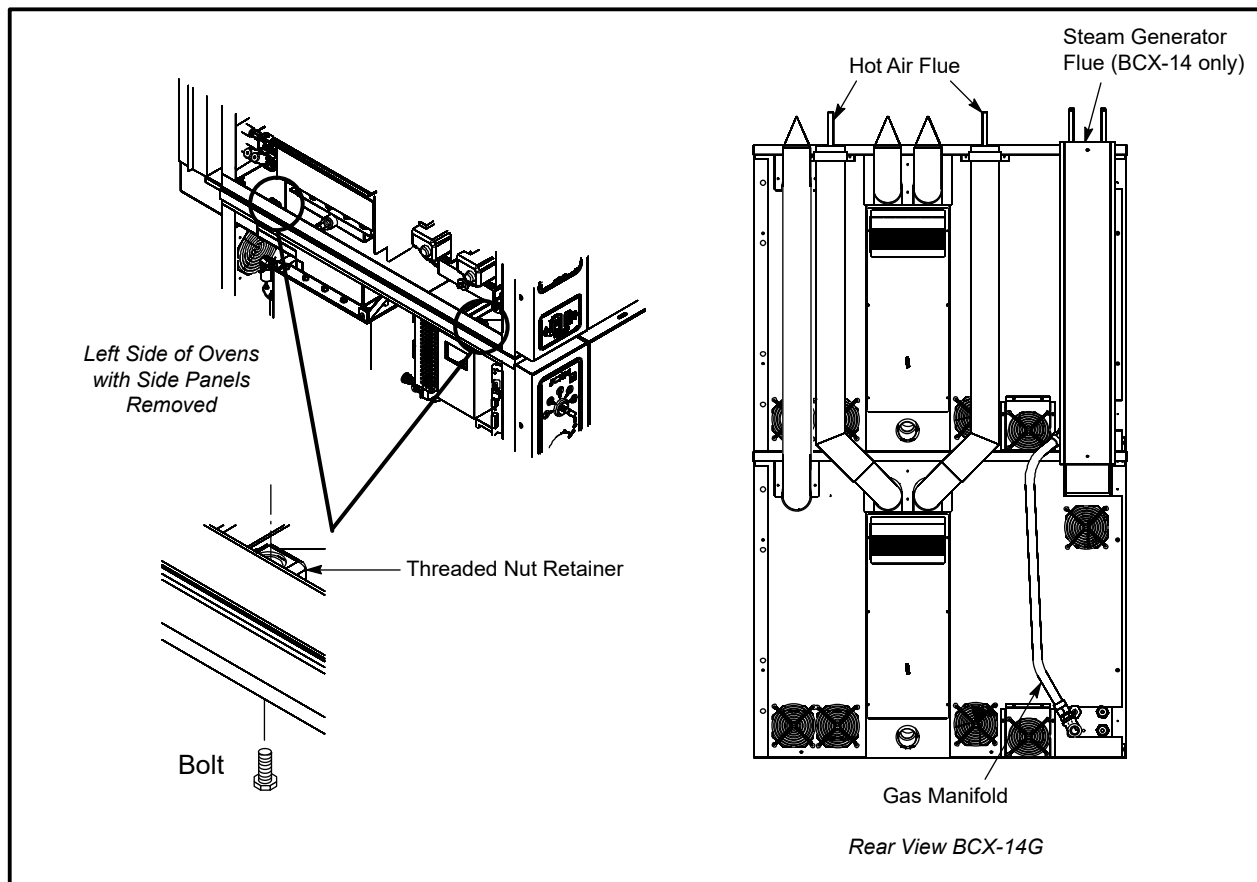

Figure 4

## Deliming System Connection and Priming (BCX-14 units only)

### DELIMING SYSTEM CONNECTION

1. Push deliming tube onto barbed fitting on oven back.



Figure 5

2. Cut deliming tube to length using the bottom of the deliming fluid reservoir in its mounted position as a guide. Install the jug weight on the deliming fluid reservoir end of the deliming tube.



Figure 6

3. Insert the end of the deliming tube with the jug weight into the deliming solution reservoir.



Figure 7

*NOTE: If needed use supplied hose retainers and self drilling screws to route the deliming tube away from hot exhaust ports.*



# Installation

## Deliming System Connection and Priming (BCX-14 units only)

### PRIME THE DELIMING PUMP

To prime the delime pump, use the following procedure for your oven control.

#### Standard Control

1. With the oven off, the display reads PRESS POWER KEY TO TURN ON. Press the TOOLS key below the large knob. The tools menu is displayed.
2. Rotate the knob to highlight PRIME DELIME PUMP. Then press the right arrow key beneath the word OK.
3. If the Manager Passcode is enabled, enter 6647 on the passcode entry screen. Then press the right arrow key beneath the word OK.
4. In order to prime the delime pump, press the key below the word PUMP on the screen. When the word PUMP is highlighted the delime pump is pumping fluid from the bottle.
5. Watch for deliming solution to flow through the tube. When the delime solution has reached the barbed fitting on the back of the oven, release the key below the word PUMP on the screen, and the pump will stop.
6. To return to the POWER screen, press the key below ESC on the screen above, then on the screen that follows.

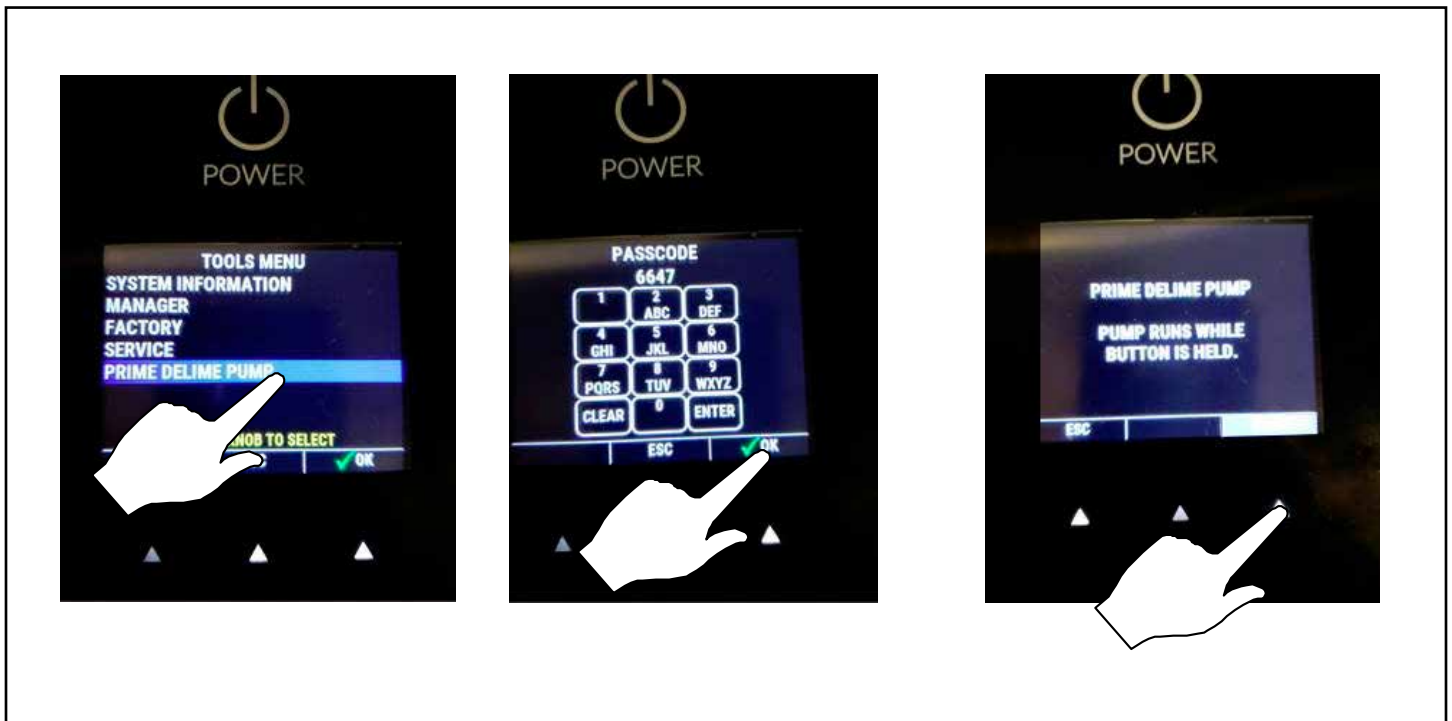

Figure 8

## Deliming System Connection and Priming (BCX-14 units only)

### SmartTouch 2™ Control

1. With the oven off, the control displays the POWER screen. Press the TOOLS key.
2. On the TOOLS MENU press the MANAGER key.
3. Press the PRIME DELIME PUMP key on the display.
4. Press and hold the PRIME key. Watch for deliming solution to flow through the tube. When the delime solution has reached the barbed fitting on the back of the oven, release the key.
5. The pump is now primed. Press the EXIT key.
6. Press the BACK key two times. The control returns to the POWER screen.

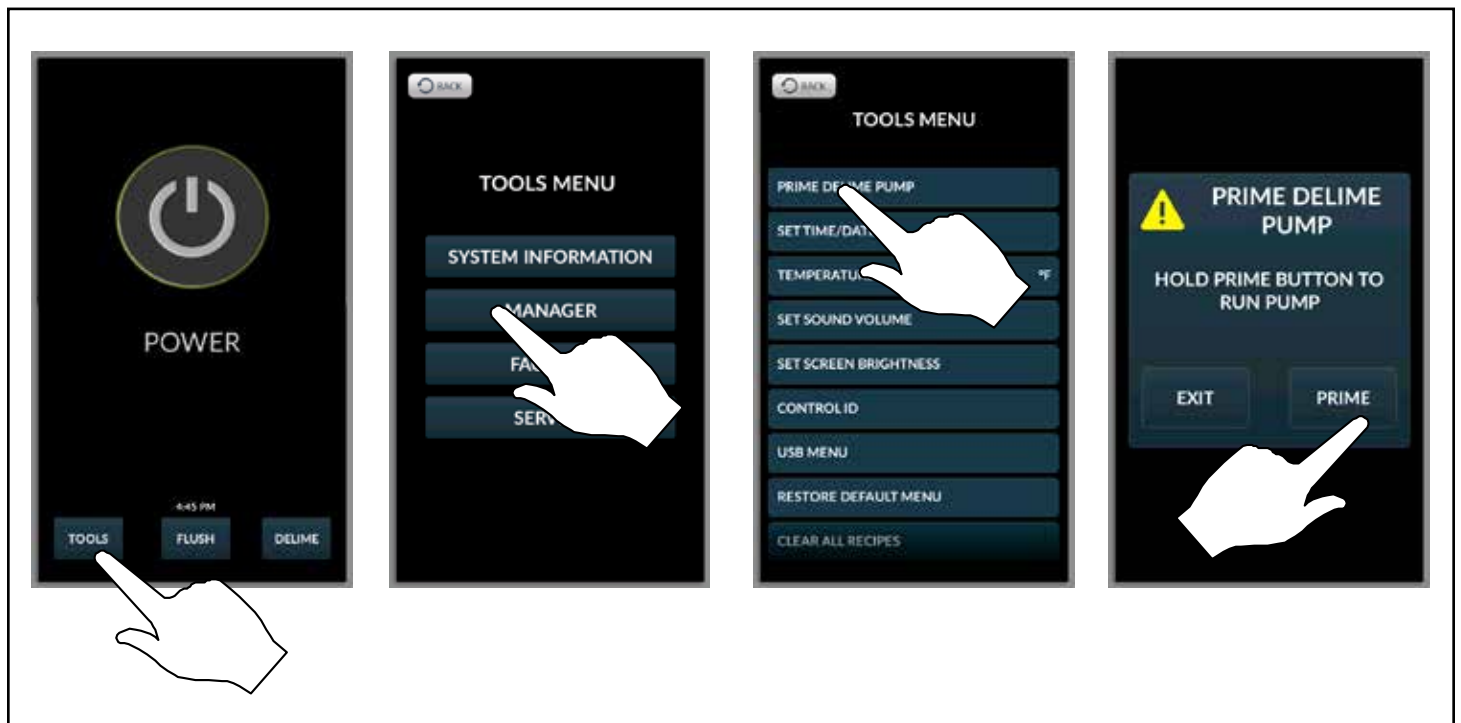

Figure 9



# Installation

## Plumbing Connections

### WATER CONNECTION

*NOTE: Hot water maximizes steam production but is not required. Cold water may be supplied to both inlets if hot water is not available.*

Connect the appliance to quality water via a pressure hose with 3/4" GHT (19mm) couplings. See below for connections. A shut off valve is to be provided adjacent to the oven.



**Operating the appliance without the water regulator installed will invalidate your warranty.**

This product must be installed by a licensed Plumber or Gas Fitter when installed within the Commonwealth of Massachusetts.

### DRAIN CONNECTION

The drain should be run to an open floor drain avoiding flexible hose that could sag and allow trapped water to accumulate. The customer must supply the piping from the oven to the drain.

*NOTE: The drain piping must consist of temperature resistant material, greater than 160°F, and be of adequate diameter not to cause flow restriction. Improper materials may deform and cause restrictions, thus affecting performance.*



**Connection must be carried out by a licensed plumber, to an open or closed drain. The drain must never end directly beneath the equipment. The drain should not be located on the same side the equipment controls are located.**

### Specific water/drain connection for City of Los Angeles

1. Each drain line from the appliance shall be routed without dips or sags to terminate above the flood level rim of an approved indirect waste receptor.
2. The appliance shall be installed in accordance with the manufacturer's printed instructions and the LAPC and LAMC, 1999 editions.
3. A backflow protection device may be required by local codes. If so, install on the potable water system directly ahead of the appliance. The backflow protection device shall be any of the following: an approved pressure type vacuum breaker installed at least 12" above the highest point of use, a double check valve backflow preventer or a reduced pressure principal backflow preventer.

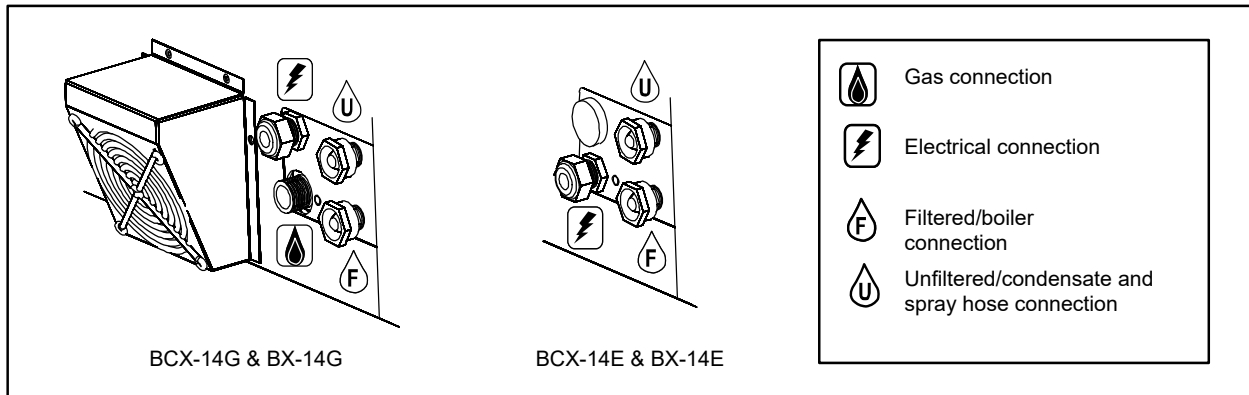

Figure 10



### ELECTRICAL CONNECTION

#### All Models

*NOTE: Electrical connections must be performed by a qualified installer only.*

Before making any electrical connections to these appliances, check that the power supply is adequate for the voltage, amperage, and phase requirements stated on the rating name plate mounted on the appliance.

The circuit breaker that is used to provide power to this appliance must have a minimum of .076" (3mm) contact spacing. The circuit breaker must meet all Local and National installation standards.

All appliances must be installed in accordance with Local or National Electrical codes.

A wiring schematic is located on the inside of the removable side panel.

*NOTE: Disconnect the power supply to the appliance before servicing.*



#### **WARNING!!**

**Improper installation may invalidate your warranty.**

#### Electric Models

A strain relief for the power supply cord is provided. The installer must supply a cord that meets all Local and National installation standards.

#### Gas Models

##### U.S. and Canadian Installations

A power cord (115V units only) is supplied with a plug attached. Plug the power cord into the desired receptacle.

This oven model uses a variable frequency inverter drive. Appliances that use variable frequency inverter drives produce high frequency noise and require filters and shielded motor cabling. This causes higher leakage current toward Earth Ground. Especially, at the moment of switching ON this can cause an inadvertent trip of the appliance's ground fault interrupter (GFCI). Some GFCIs are more sensitive than others. Blodgett has qualified the Pass and Seymour brand, part number 2095, 20 A, 125 VAC, 60 Hz, specification grade GFCI duplex receptacle as being immune to the variable frequency inverter drive's noise. Blodgett recommends using this specific GFCI for this model oven.



#### **WARNING!!**

**If the supply cord is damaged, it must be replaced by a special cord or assembly available from the manufacturer or its service agent.**



# Installation

## Gas Connection

### GAS PIPING

A properly sized gas supply system is essential for maximum oven performance. Piping should be sized to provide a supply of gas sufficient to meet the maximum demand of all appliances on the line without loss of pressure at the equipment.

Example:

*NOTE: BTU values in the following example are for natural gas.*

You purchase a BCX-14G to add to your existing cook line.

1. Add the BTU rating of your current appliances.

Pitco Fryer	120,000 BTU
6 Burner Range	60,000 BTU
Deck Oven	50,000 BTU
Total	230,000 BTU

2. Add the BTU rating of the new oven to the total.

Previous Total	230,000 BTU
BCX-14G	115,000 BTU
New Total	345,000 BTU

3. Measure the distance from the gas meter to the cook line. This is the pipe length. Let's say the pipe length is 40' (12.2 m) and the pipe size is 1" (2.54 cm).

4. Use the appropriate table to determine the total capacity of your current gas piping.

The total capacity for this example is 375,000 BTU. Since the total required gas pressure, 345,000 BTU is less than 375,000 BTU, the current gas piping will not have to be increased.

*NOTE: The BTU capacities given in the tables are for straight pipe lengths only. Any elbows or other fittings will decrease pipe capacities. Contact your local gas supplier if you have any questions.*

### Maximum Capacity of Iron Pipe in Cubic Feet of Natural Gas Per Hour

(Pressure drop of 0.5 Inch W.C.)

PIPE LENGTH (FT)	NOMINAL SIZE, INCHES				
	3/4"	1"	1-1/4"	1-1/2"	2"
10	360	680	1400	2100	3950
20	250	465	950	1460	2750
30	200	375	770	1180	2200
40	170	320	660	990	1900
50	151	285	580	900	1680
60	138	260	530	810	1520
70	125	240	490	750	1400
80	118	220	460	690	1300
90	110	205	430	650	1220
100	103	195	400	620	1150

*From the National Fuel Gas Code Part 10 Table 10-2*

### Maximum Capacity of Pipe in Thousands of BTU/hr of Undiluted L.P. Gas at 11" W.C.

(Pressure drop of 0.5 Inch W.C.)

PIPE LENGTH (FT)	OUTSIDE DIAMETER, INCHES		
	3/4"	1"	1-1/2"
10	608	1146	3525
20	418	788	2423
30	336	632	1946
40	287	541	1665
50	255	480	1476
60	231	435	1337
70	215	404	1241
80	198	372	1144
90	187	351	1079
100	175	330	1014

*From the National Fuel Gas Code Part 10 Table 10-15*

### PRESSURE REGULATION AND TESTING

The gas pressure to the appliance must be rated for each appliance while the burners are on. A sufficient gas pressure must be present at the inlet to satisfy these conditions. Refer to the table below for correct gas pressure.

Each appliance has been adjusted at the factory to operate with the type of gas specified on the rating plate.

Each oven is supplied with a regulator to maintain the proper gas pressure. The regulator is essential to the proper operation of the oven and should not be removed.

**DO NOT INSTALL AN ADDITIONAL REGULATOR WHERE THE UNIT CONNECTS TO THE GAS SUPPLY UNLESS THE INLET PRESSURE IS GREATER THAN 14" W.C. (1/2 PSI) (37mbar).**

The oven and its individual shutoff valve must be disconnected from the gas supply piping system during any pressure testing of that system at test pressures in excess of 1/2 psig (3.45kPa).

The oven must be isolated from the gas supply piping system by closing its individual manual shutoff valve during any pressure testing of the gas piping system at test pressures equal or less than 1/2 psig (3.45kPa).

Prior to connecting the appliance, gas lines should be thoroughly purged of all metal filings, shavings, pipe dope, and other debris. After connection, the appliance must be checked for correct gas pressure.

### U.S. and Canadian Installations

Installation must conform with local codes, or in the absence of local codes, with the National Fuel Gas Code, NFPA54/ANSI Z223.1-Latest Edition, the Natural Gas Installation Code CAN/CGA-B149.1 or the Propane Installation Code, CAN/CGA-B149.2 as applicable.

### General Export Installations

Installation must conform with Local and National installation standards. Local installation codes and/or requirements may vary. If you have any questions regarding the proper installation and/or operation of your appliance, please contact your local distributor. If you do not have a local distributor, please call Blodgett Combi at 0011-802-658-6600.

GAS PRESSURE					
Gas Type	Inlet Pressure	Orifice Size at Sea Level		Manifold Pressure	
		Hot Air	Steam	Hot Air	Steam
<b>BCX-14G</b>					
Natural	7-14" W.C.	.0531" dia	.042" dia	3.5" W.C.	3.5" W.C.
Propane	12-14" W.C.	.032" dia	.026" dia	10" W.C.	10" W.C.
<b>BX-14G</b>					
Natural	7-14" W.C.	.0531" dia	—	3.5" W.C.	—
Propane	12-14" W.C.	.032" dia	—	10" W.C.	—



# Installation

## Gas Hose Restraint

If the appliance is mounted on casters, a commercial flexible connector with a minimum of 3/4" (1.9 cm) inside diameter must be used along with a quick connect device.

A restraint must be used to limit the movement of the appliance so that no strain is placed upon the flexible connector. The restraint should be fastened to the base frame of the oven as close to the flexible connector as possible. It should be short enough to prevent any strain on the connector. With the restraint fully stretched the connector should be easy to install and quick connect.

The restraint (ie: heavy gauge cable) should be attached without damaging the building. DO NOT use the gas piping or electrical conduit for the attachment of the permanent end of the restraint! Use anchor bolts in concrete or cement block. On wooden walls, drive hi test wood lag screws into the studs of the wall.



### WARNING!!

**If the restraint is disconnected for any reason it must be reconnected when the appliance is returned to its original position.**

### U.S. and Canadian installations

The connector must comply with the Standard for Connectors for Movable Gas Appliances, ANSI Z21.69 or Connectors For Moveable Gas Appliances CAN/CGA-6.16 and a quick disconnect device that complies with the Standard for Quick-Disconnect Devices for Use With Gas Fuel, ANSI Z21.41 or Quick Disconnect For Use With Gas Fuel CAN 1-6.9. Adequate means must be provided to limit the movement of the appliance without depending on the connection and the quick disconnect device or its associated piping.

A drip leg must be used at each appliance. Refer to NFPA54/ANSI Z223.1 - Latest Edition (National Fuel Gas Code) for proper drip leg installation.

### General export installations

Installation must conform with Local and National installation standards. Local installation codes and/or requirements may vary. If you have any questions regarding the proper installation and/or operation of your appliance, please contact your local distributor. If you do not have a local distributor, please call Blodgett Combi at 0011-802-658-6600.

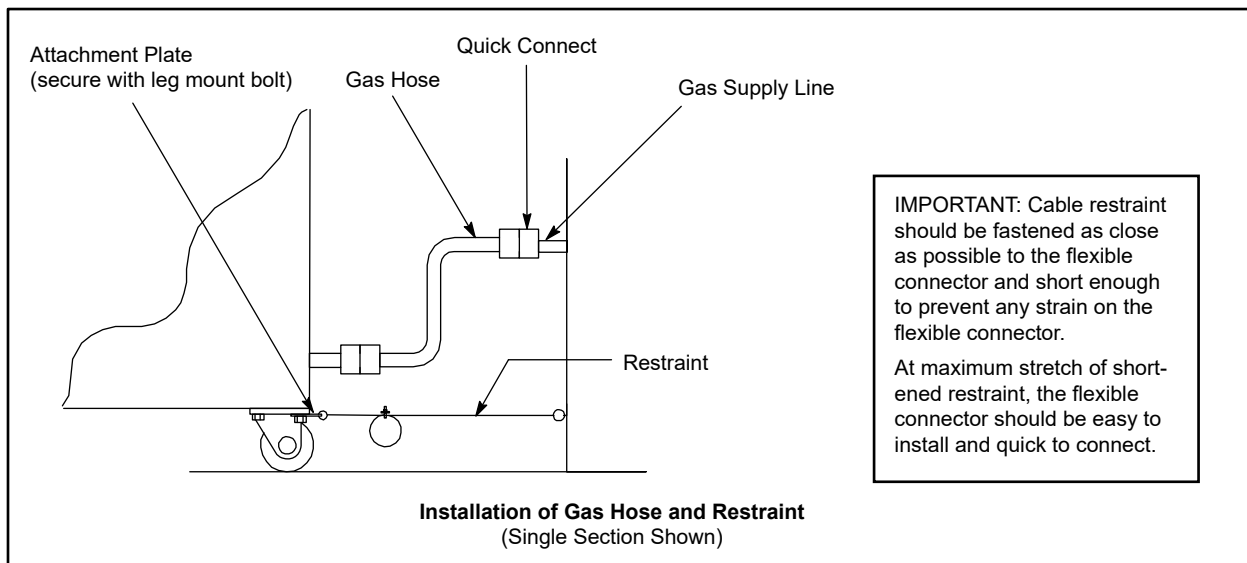

Figure 11

## Adjustments

Before applying power to the appliance for the first time, check for the following conditions:

- All electrical safety provisions have been adhered to and the electrical connections are correct.
- Water is connected, turned on and all of the connections are water tight.
- The pan holders are inserted into the oven cavity.
- Cardboard has been removed from oven cavity.
- Gas has been turned on, if gas unit.

### DOOR ADJUSTMENT

The door catch may be adjusted in and out using the following procedure:

1. Flip the rubber boot on the catch towards you.
2. Loosen the locknut to make adjustment.
3. Rotate the catch clockwise or counter clockwise to get proper adjustment.
4. Retighten locknut, assuring the catch is vertical.
5. Flip the rubber boot back into position.

The hinges can also be adjusted as follows:

1. Loosen the two 1/4-20 bolts on the top of the hinge plate and the two bolts on the bottom hinge plate.
2. Apply pressure to the door on the corners to get the proper seal. While pushing, tighten the bolts in place.

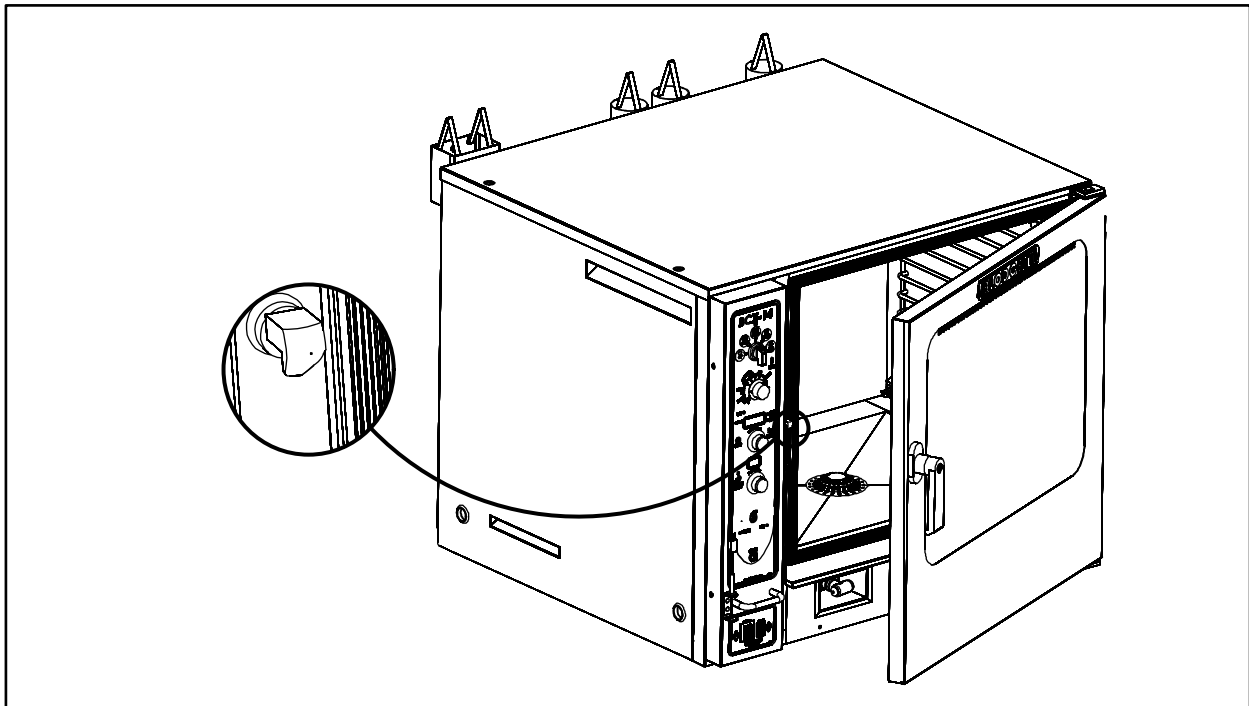

Figure 12



# Installation

---

## Final Check Lists



### **WARNING!!**

**Final check list must be performed by a qualified installer only.**

### **ELECTRICAL CONTROL COMPARTMENT**

- Voltage to appliance matches rating plate

### **PLUMBING FINAL CHECK**

- Incoming water pressure within appliance specification.
- Atmospheric vented drain in place.
- Water feed lines intact without leaks.
- Ensure proper clearance as detailed.
- Delime system has been primed. BCX-14 only.

### **OVEN OPERATIONAL TESTS**

*NOTE: Checks to be made by customer or authorized service agent.*

#### **Cool Down Mode**

- Check that the fan runs with the door open.

#### **Steam Mode**

Turn on STEAM mode and set thermostat to 200°F. Verify the following:

- The oven is preheating and shows the actual cavity temperature rising.
- Boiler heat demand shuts off at approximately 200°F (100°C) and regulates the cavity temperature to 200°F.
- Set timer for 1 minute and start. Be sure the beeper sounds when the time expires.
- Power light turns on.
- Unit produces steam, window fogs, door seal does not leak.

#### **Combi Mode**

Change to COMBI mode, set thermostat to 350°F (177°C) and verify:

- The oven is preheating and shows the actual cavity temperature rising.
- Heat demand shuts off at 350°F (177°C) and oven maintains 350°F (177°C).
- Fan shuts off with door open.

#### **Hot Air Mode**

Change to HOT AIR mode and set thermostat to 400°F (204°C) and verify:

- The oven is preheating and shows the actual cavity temperature rising.
- Heat demand shuts off at 400°F (204°C) and oven maintains 400°F (204°C).
- Fan shuts off with door open.

#### **Steam On Demand Mode**

Turn the oven to Hot Air mode. Press the steam on demand key. Set Steam On Demand for 1 minute.

- The Steam On demand timer is counting down.
- The steam on demand counter goes away after the timer expires.

#### **Lights**

- Press switch to ensure lights come on.

#### **Cavity Vent**

- Press the vent key to ensure that the vent opens and closes.

#### **Fan Speed**

- Ensure all fan speeds work on the preheated oven using the fan key and knob.

## Safety Information for Gas Units

The information contained in this section is provided for the use of qualified operating personnel. Qualified operating personnel are those who have carefully read the information contained in this manual, are familiar with the functions of the oven and/or have had previous experience with the operation of the equipment described. Adherence to the procedures recommended herein will assure the achievement of optimum performance and long, trouble-free service.

Please take the time to read the following safety and operating instructions. They are the key to the successful operation of your Blodgett oven.



### SAFETY TIPS

#### For your safety read before operating

What to do if you smell gas:

- What to do if you smell gas:
- DO NOT try to light any appliance.
- DO NOT touch any electrical switches.
- Use an exterior phone to call your gas supplier immediately.
- If you cannot reach your gas supplier, call the fire department.

#### What to do in the event of a power failure:

- Turn all switches to off.
- DO NOT attempt to operate the appliance until the power is restored.

*NOTE: In the event of a shut-down of any kind, allow a five (5) minute shut off period before attempting to restart the oven.*

#### General safety tips:

- DO NOT use tools to turn off the gas control. If the gas cannot be turned off manually do not try to repair it. Call a qualified service technician.
- If the oven needs to be moved for any reason, the gas must be turned off and disconnected from the appliance before removing the restraint cable. Reconnect the restraint after the oven has been returned to its original location.
- DO NOT remove the control panel cover unless the oven is unplugged.



# Operation

## Power Switches

### CONTROLS IDENTIFICATION

#### 1. HEAT CONTROL SWITCH

**Gas Ovens** - Used to turn gas on or off.

**Electric Ovens** - Used to turn power to the elements on or off.

#### 2. CIRCUIT BREAKER - Used to turn power to the unit on or off. This switch should always stay ON.

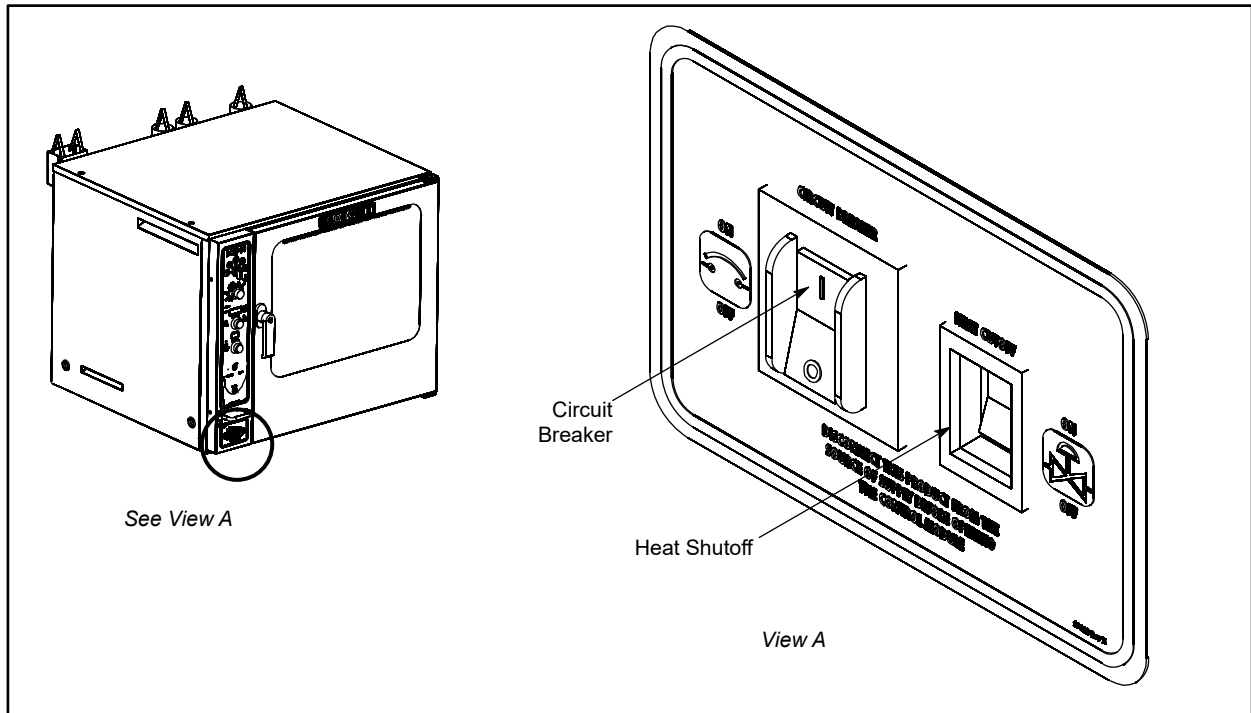

Figure 13



## Standard Controls

### CONTROLS IDENTIFICATION

1. POWER KEY - used to place control in and out of standby mode
2. DISPLAY - displays time, temperature, humidity and other information related to oven function and/or programming
3. DISPLAY KEYS - context sensitive keys used to interact with the display
4. HUMIDITY/MODE KEY - used to select cooking mode and set or change the % of humidity
5. TEMP KEY - used to set or change the bake temperature
6. CONTROL KNOB - used to change values for time, temperature, humidity, etc.
7. TIME KEY - used to set or change the cook time
8. START KEY - press to start the cook cycle
9. VENT KEY - press to manually open and close the vent
10. +1 MINUTE KEY - press at any time to add additional minute to the cook time
11. PROBE KEY - press to use core probe cooking
12. FAN KEY - used to select fan speed
13. STEAM ON DEMAND KEY - press to add 100% humidity at any time during the cook cycle
14. LIGHTS KEY - press to turn the oven lights on and off
15. RECIPES KEY - press to access product programs or to add/edit a product
16. COOL DOWN KEY - initiates oven cool down cycle
17. TOOLS KEY - press to enter manager programming
18. USB PORT AND COVER - used to transfer recipes to and from the control
19. HEAT CUTOFF - used to turn heat source off
20. CIRCUIT BREAKER - Used to turn power to the unit on or off
21. CORE PROBE CONNECTION - plug core temperature probe in here when using probe cooking

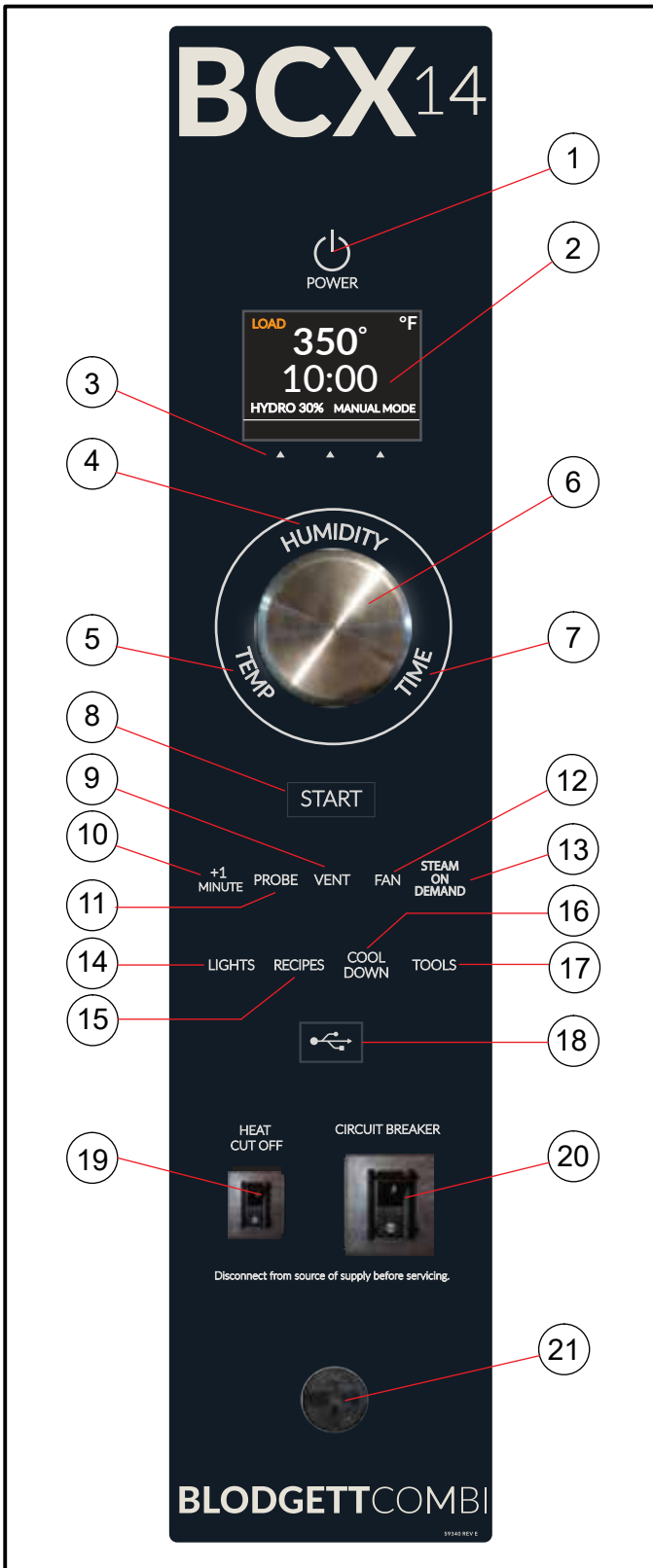



Figure 14



# Operation

## Standard Controls

### OVEN STARTUP

1. Be sure the circuit breaker and heat cutoff switches are in the ON position. The display flashes PRESS  POWER KEY TO TURN ON.
2. Press the POWER KEY (1). The display reads “To begin press time/temp/humidity key”. Each key illuminates in succession. Press any key or rotate the knob.
3. The display reads PREHEAT and the oven heats to the last manual set temperature.

The display reads LOAD, the start key flashes and the alarm beeps when the oven is at temperature and ready to bake.

### MANUAL COOKING

1. Press the HUMIDITY/MODE KEY (4). Turn the dial until desired cooking mode is displayed. Choose from Steam, Combi, Hot Air or Retherm.

For Combi and Retherm, set the desired humidity level by pressing the center display key. Turn the dial until the correct humidity level is displayed. Press the right display key to save.

*NOTE: For Steam and Hot Air modes the humidity level are fixed at 100% and 0%.*

2. Press the TIME KEY (7). Rotate the CONTROL KNOB (6) to enter the desired cook time. Press any key to accept the value.

*NOTE: Turn the knob slowly to adjust in seconds.  
Turn the knob quickly to adjust in minutes.*

3. Press the TEMP KEY (5). Rotate the CONTROL KNOB (6) to enter the desired cook temperature. Press any key to accept the value. The oven preheats to the new set temperature.

*NOTE: In steam mode the temperature range is limited to 85°F - 225°F.*

4. When the display reads LOAD and the START KEY (8) flashes, open the door and load the product.
5. Press the START KEY (8) to begin the cook cycle. The timer counts down.

*NOTE: See page 3 for adjustments that can be made during any cook cycle.*

6. When the cook cycle is complete, the alarm beeps and the display reads DONE. Press any key to silence alarm. Select CANCEL using the right display key to exit the cook cycle.

7. Remove the product from the oven.

### MANUAL CORE PROBE COOKING

1. Press the HUMIDITY/MODE KEY (4). Turn the dial until desired cooking mode is displayed. Choose from Steam, Combi, Hot Air or Retherm.

For Combi and Retherm, set the desired humidity level by pressing the center display key. Turn the dial until the correct humidity level is displayed. Press the right display key to save.

*NOTE: For Steam and Hot Air modes the humidity level are fixed at 100% and 0%.*

2. Press the TEMP KEY (5). Rotate the CONTROL KNOB (6) to enter the desired cavity cook temperature. Press any key to accept the value. The oven preheats to the new cavity set temperature.

3. Press the PROBE KEY (11). Rotate the CONTROL KNOB (6) to enter the desired product setpoint temperature.

4. Insert cooking probe into the center of the product. Plug the core probe into the CORE PROBE CONNECTION (21). Load the product into the oven.

*NOTE: Pressing the START KEY (8) is not necessary while cooking with the core probe.*

*NOTE: See page 3 for adjustments that can be made during any cook cycle.*

5. When the product has reached the setpoint temperature, the alarm beeps and the display reads DONE. Unplug the core probe to silence the alarm and exit the cook cycle.

6. Remove the product from the oven.

### MANUAL CORE PROBE COOK & HOLD

1. Press the HUMIDITY/MODE KEY (4). Turn the dial until desired cooking mode is displayed. Choose from Steam, Combi, Hot Air or Retherm.

For Combi and Retherm, set the desired humidity level by pressing the center display key. Turn the dial until the correct humidity level is displayed. Press the right display key to save.

*NOTE: For Steam and Hot Air modes the humidity level are fixed at 100% and 0%.*

2. Press the TEMP KEY (5). Rotate the CONTROL KNOB (6) to enter the desired cavity cook temperature. Press any key to accept the value. The oven preheats to the new cavity set temperature.

## Standard Controls

3. Press the PROBE KEY (11). Rotate the CONTROL KNOB (6) to enter the desired product setpoint temperature.
4. Press the center display key under the word HOLD. HOLD will be highlighted in blue indicating that the hold mode is active.
5. Insert cooking probe into the center of the product. Plus the core probe into the CORE PROBE CONNECTION (21).

*NOTE: Pressing the START KEY (8) is not necessary while cooking with the core probe.*

*NOTE: See page 23 for adjustments that can be made during any cook cycle.*

As the product temperature rises, the oven cavity temperature decreases.

6. When the product reaches the setpoint temperature, a short alarm sounds. The cavity temperature jumps to 4°F above the product setpoint. This temperature will hold the product, keeping it warm without continuing the cooking process.

The display counts up the time the product has been holding.

7. Unplug the core probe to remove the product from the oven.

### PROGRAMMED COOKING

1. Press the RECIPES KEY (15). The display lists all of the currently programmed recipes. Rotate the knob until the desired product recipe is highlighted. Press OK using the right display key to select the product.
2. The oven preheats to the set temperature. When the display flashes LOAD, open the door and load the product.
3. Press the START KEY (8) to begin the cook cycle. The timer counts down.

*NOTE: See page 23 for adjustments that can be made during any cook cycle.*

4. When the cook cycle is complete, the alarm beeps and the display reads DONE. Press any key to silence alarm. Select CANCEL using the right display key to exit the cook cycle.
5. Remove the product from the oven.

### COOK CYCLE ADJUSTMENTS

The following adjustments can be made at any time during the cook cycle.

#### Vent Moisture from the Oven Cavity

1. Press the VENT KEY (9). This manually opens the vent until the key is pressed again to close it.

#### Cancel a Cook Cycle

1. To cancel the cook cycle, press the right display key under the word cancel.

#### Steam on Demand

1. To add 100% humidity at any time during a cook cycle, press the STEAM ON DEMAND KEY (13).
2. Rotate the knob to enter the length of time you wish to inject the moisture.
3. Select OK to start injecting humidity.

#### Adding Time

1. Press the +1 MINUTE KEY (10). One minute is added to the timer for each time the key is pressed.

#### Fan Adjustments

1. Press the FAN KEY (12). Rotate the knob to select between four fan speeds (gentle, low, high and turbo). Press OK to select the desired fan speed.
2. Select FAN DELAY using the center display key. Rotate the knob to enter the desired fan delay. Select OK to save the fan delay increment.
3. Select FAN REV using the left display key. Rotate the knob to enter the desired length of time between fan reversals. Press OK to save the reversal increment.

### COOL DOWN

*NOTE: The unit can be cooled down rapidly for steaming, cleaning, etc.*

1. To cool down the oven cavity, open the door and press the COOL DOWN KEY (16) and open the door.
2. The oven automatically shuts down when the oven reaches the cool down temperature.



# Operation

---

## Standard Controls

### OVEN SHUTDOWN

1. Press the COOL DOWN KEY (16). The display reads COOLING and gives the actual cavity temperature. To speed up the cool down process, open the doors.
2. When the oven has cooled down, the display reads OFF PRESS POWER KEY TO TURN ON.

*NOTE: The lights shut off and the vent closed automatically at the end of the cool down cycle.*

### PROGRAMMING A RECIPE

*NOTE: The control can hold 100 recipes. Each recipe may have up to 10 cooking stages.*

1. Press the RECIPES KEY (15). Rotate the knob to select NEW from the bottom of the recipe list.
2. Select EDIT using the left display key. A touchscreen keyboard is displayed. Use the keyboard to enter the desired recipe name.

*NOTE: Product names may be up to 15 characters long and can contain letters, numbers, spaces and special characters.*

*Select OK to save the product name.*

3. The control displays a set of default parameters for the first cooking stage. Select EDIT using the left display key to change these parameters.
4. Press the parameter you wish to change. Rotate the knob to the desired value. Select OK to save the new value.
5. Repeat step 4 for each parameter you wish to change.

To program a probe cooking stage:

- c. Press the PROBE/TIME parameter to toggle to Probe.
  - d. Rotate the knob to select the desired product set-point temperature. Select OK to save the temperature.
  - e. Rotate the knob to highlight the probe step in the step list. The hold toggle appears in the upper left corner of the screen. Rotate the knob to highlight the word HOLD. Select EDIT using the left display key to toggle between YES and NO.
6. To add a cooking step, select ADD using the right display key. The first step is copied. Repeat #5 to set parameters for the new step.
  7. To delete any step, rotate the knob to highlight the step. Select DEL RECIPE using the right display key.

8. To save the recipe and exit the edit mode, select ESC using the center display key.
9. To delete a recipe, with the recipe name highlighted during the edit process, press and hold the left display key until the display returns to the recipe list. The recipe will now be deleted from the list.

### USING THE MANAGER TOOLS

The manager level screens provide tools to set the time and date, adjust the volume of the beeper and upload/download recipes using the USB port.

#### To access the manager level screens:

1. Press the TOOLS KEY (17).
2. Rotate the knob to select MANAGER. Select OK using the right display key.
3. Use the keypad to enter the code 6647.

### USING THE USB PORT

1. From the manager level screens, rotate the knob to scroll to USB. Select OK using the right display key.
2. Rotate the knob to highlight either "Store menu to USB" or "Load menu from USB". Select OK using the right display key.

#### Store menu to the USB

1. Use the keypad to enter a new filename. Select OK using the right display key.
2. Once upload is complete, press ESCAPE to return to the previous screen.

#### Load menu from USB

1. Rotate the knob to select the desired file for download. Select OK using the right display key.
2. Once download is complete, press ESCAPE to return to the previous screen.

## SmartTouch 2 Touchscreen Control

### CONTROL DESCRIPTION

1. TOUCHSCREEN - interactive display for oven functioning and/or programming
2. USB Port and COVER - Use to transfer recipes and data to/from the control
3. HEAT CUTOFF - used to turn heat source off
4. CIRCUIT BREAKER - Provides circuit protection for the oven controls. DO NOT use as a power switch.
5. CORE PROBE CONNECTION - plug core temperature probe in here when using probe cooking



Figure 15



# Operation

## SmartTouch 2 Touchscreen Control

### MANUAL MODE COOKING

1. Press POWER to turn on the oven.
2. Press MANUAL to proceed to the manual cook screen.
3. Set the following cooking parameters from the MANUAL screen.

**Mode Selection** - Press to select one of four cooking modes.

**Humidity** - Use the slider at the top of screen to adjust cavity moisture content in 5% increments. To enter an exact value, press and hold the slider until the keypad is displayed. Press ENTER to save.

**Temperature** - Press the temperature text and enter the desired oven temperature on the keypad provided. Press ENTER to save.

**Cook Time** - Press the time text and enter the desired cook time on the keypad provided. Press ENTER to save. Press the units text to toggle between hours/minutes and minutes/seconds.

**Fan Speed** - Press the fan speed text to toggle between Gentle, Low, High or Turbo.

*NOTE: If the oven is preheating or cooling down, the fan speed will automatically run in high until the oven reaches the set temperature.*

4. Press the FLYOUT MENU arrow to access the following parameters.

**Actual Temp** - Press to display the actual cavity temperature

**Core Probe Cooking** - Press to use the core probe cooking feature.

**Add a Minute** - Press +1 MIN to add 1 minute of time at any point during the cook cycle.

**Steam on Demand** - Press to add 100% humidity at any time. Use the provided keypad to enter desired length of time. Press ENTER to save. The display counts down the steam on demand time remaining.

**Vent Position** - The vent can be opened or closed by toggling the VENT icon at any point during the cook cycle.

**Fan Delay** - Press the fan delay icon. Use the provided keypad to enter a fan delay increment. Press ENTER to save.

**Fan Reversal Interval** - To adjust the fan reversal time, press the FAN REVERSAL icon. Enter the desired reversal interval on the keypad provided. Press

ENTER to save.

**Lights** - At any time the lights can be turned on or off by toggling the LIGHT icon.

5. The oven preheats to the set temperature.

*NOTE: START will not be displayed until the oven has reached the set temperature.*

6. Press START to begin cooking. The display counts down. Press CANCEL at any time to stop the cook cycle.
7. When the cook time has expired, the display flashes DONE and the alarm sounds. Press CANCEL to silence the alarm. The display returns to the previous cook time setting.
8. Press BACK to exit out of MANUAL mode.

### CORE PROBE COOKING

1. Press POWER to turn on the oven.
2. Press MANUAL to proceed to the manual cook screen. Set the desired cooking mode, humidity, cook temp and fan speed.
3. Select Core Probe Cooking from the flyout menu.
4. Press the probe target text. Enter the desired finished product temperature on the keypad provided. Press ENTER to save.
5. Insert a core probe into the probe outlet on the control panel.
6. The HOLD button appears. To enable the Cook & Hold feature, press the hold button.
7. When the product has reached the set core temperature the display reads DONE.
8. **Cook Only** - Unplug the core probe and remove the product.

**Cook & Hold** - The oven cavity temperature adjusts to the optimum temperature for holding the product without overcooking. The display counts up the time the item has been holding. The cavity temperature jumps to 4°F above the product setpoint. This temperature will hold the product, keeping it warm without continuing the cooking process.



## SmartTouch 2 Touchscreen Control

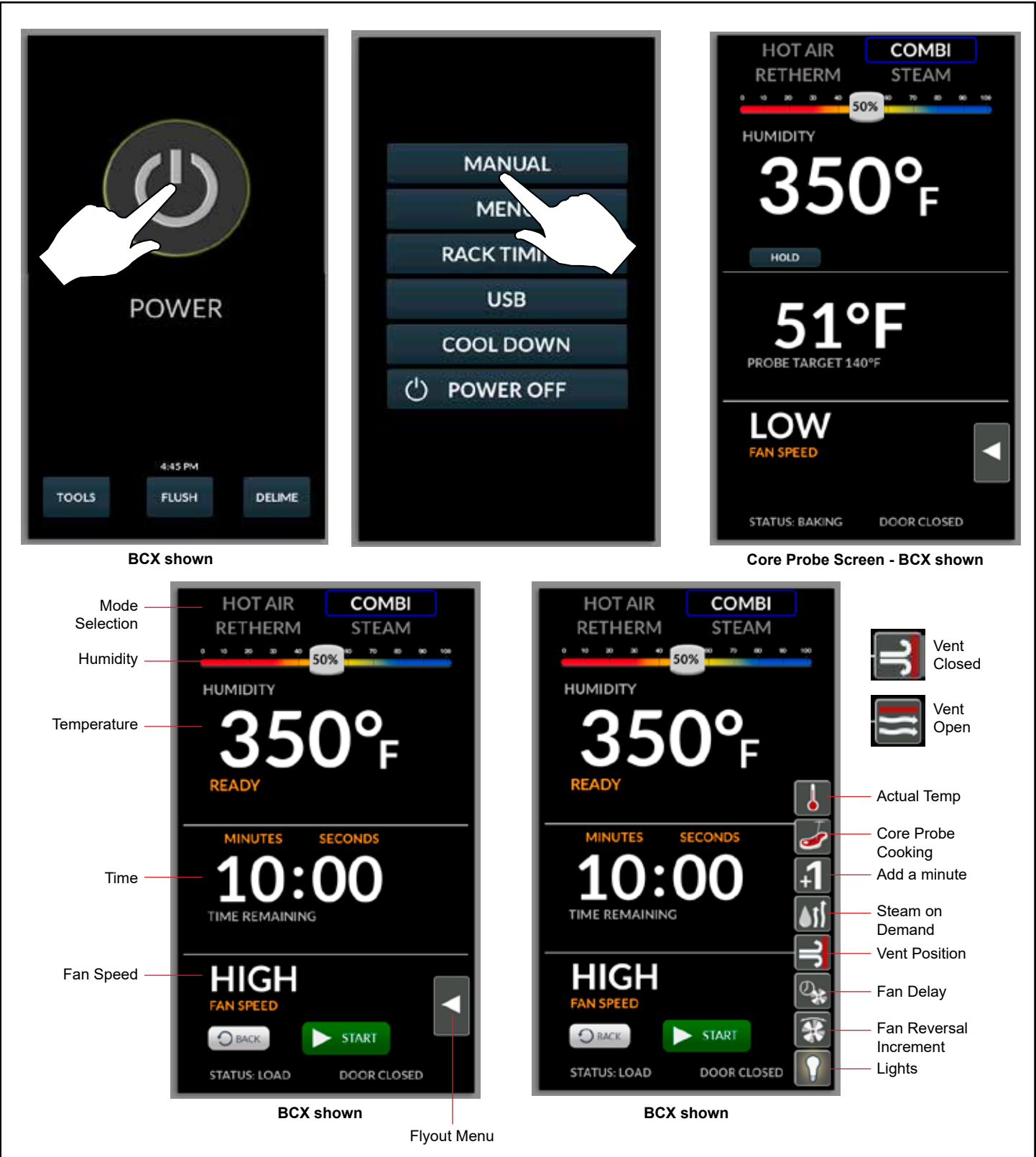

Figure 16



# Operation

## SmartTouch 2 Touchscreen Control

### MENU MODE

#### Create a New Recipe

1. From the mode selection screen, select MENU.



Figure 17

2. Press right arrow key to advance to final category page. Then press NEW RECIPE key.

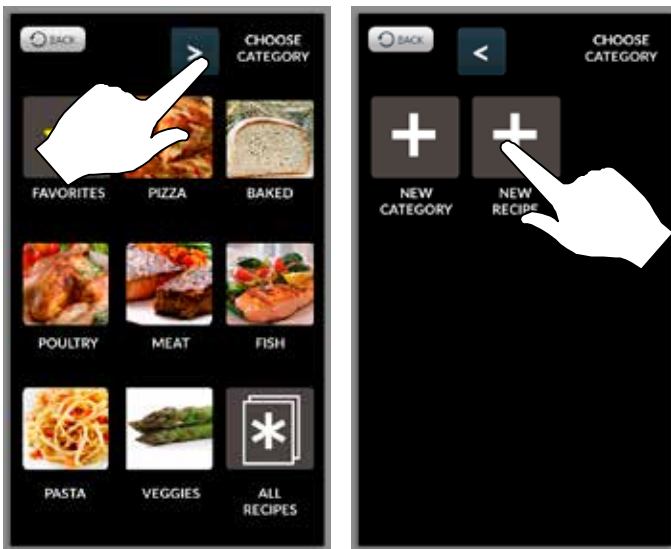

Figure 18

3. The NEW RECIPE screen is displayed. Press the camera icon.

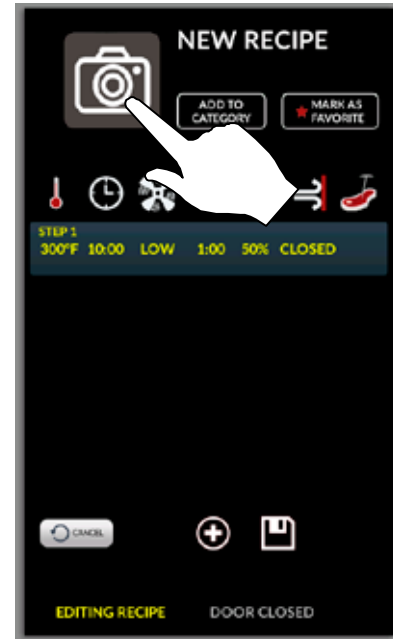

Figure 19

4. Select an icon to represent the recipe.



Figure 20

5. Press NEW RECIPE text. Use the keypad provided to enter a recipe name. Press the DISK ICON to save.



## SmartTouch 2 Touchscreen Control



Figure 21

step.

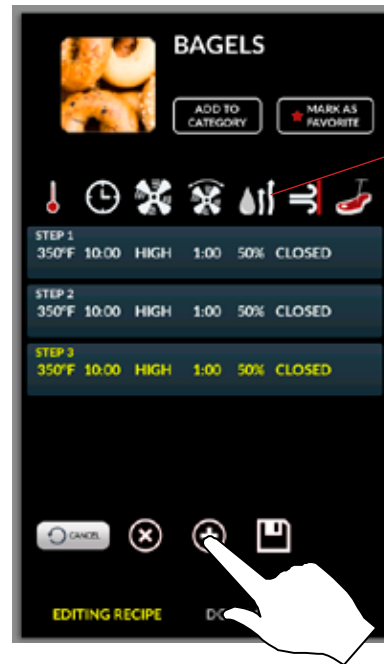

Figure 23

6. OPTIONAL: Press MARK AS FAVORITE if desired.
7. OPTIONAL: To add to an existing category, press ADD TO CATEGORY. Select category. Press DONE.

9. Once all steps have been entered, press the DISK ICON to save the recipe



Figure 22

### Edit an Existing Recipe

1. From the mode selection screen, select MENU.
2. Press and hold the icon for the recipe you wish to edit.
3. Choose edit, copy or delete from the pop up menu.

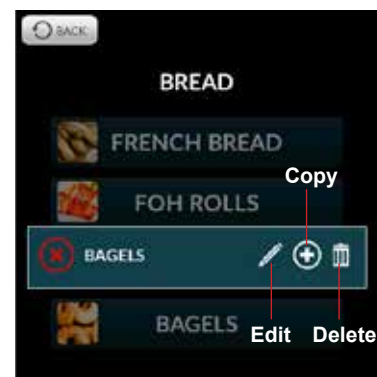

Figure 24

8. Enter parameters for the first cooking step. Press the icon above each parameter to adjust settings. Press the + to add a step. Press the X to delete the current



# Operation

## SmartTouch 2 Touchscreen Control

### Create a New Category

1. From the mode selection screen, select MENU.



Figure 25

ICON to save.

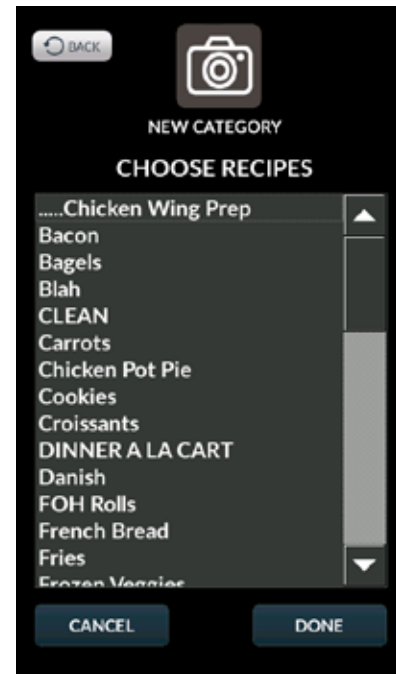

Figure 27

2. Press right arrow key to advance to final category page. Then press NEW CATEGORY key.

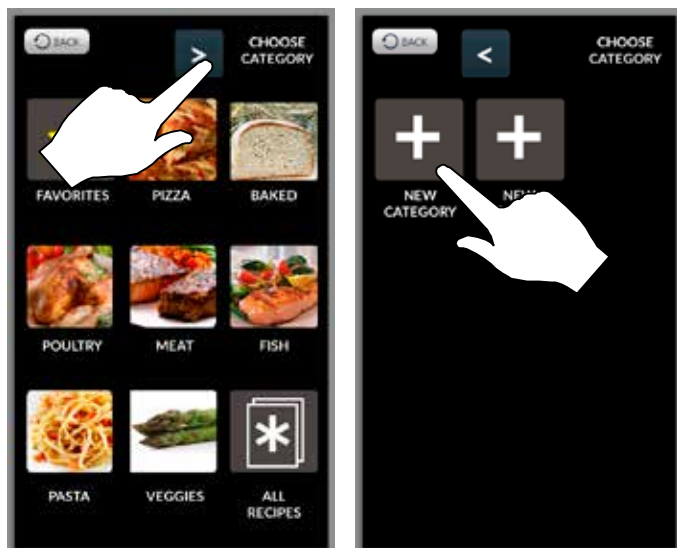

Figure 26

5. Select the recipes to include in the category. Press DONE to save.

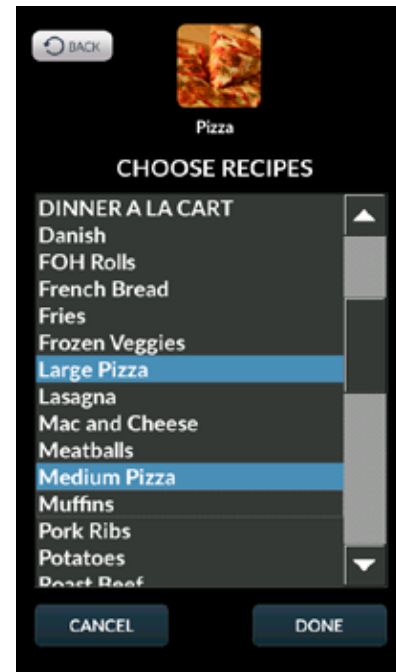

Figure 28

3. Press the camera to select an icon to represent the group.
4. Press the NEW CATEGORY text. Use the keypad provided to enter a category name. Press the DISK



## SmartTouch 2 Touchscreen Control

### Edit Existing Category

1. From the mode selection screen, select MENU.
2. Press and hold the icon for the category you wish to edit.
3. Choose edit, copy or delete from the pop up menu.

### Menu Mode Cooking

1. From the mode selection screen, press MENU.
2. Select a recipe using one of the following:
  - f. If the recipe is one of your favorites, press FAVORITES. Then select the recipe.
  - g. If the recipe is part of a category, select the category. Then select the recipe.
  - h. Press ALL RECIPES, scroll through the list using the left and right arrow keys. Select the recipe.



Figure 29

3. The control enters the Menu Cooking screen. Press the START KEY to begin the cook cycle.

*NOTE: START will not be displayed until the oven has reached the programmed set temperature.*

*NOTE: If the oven is preheating or cooling down, the fan speed will automatically run in high until the oven reaches the set temperature.*

*NOTE: To edit a cooking step, press and hold the step before starting the program.*

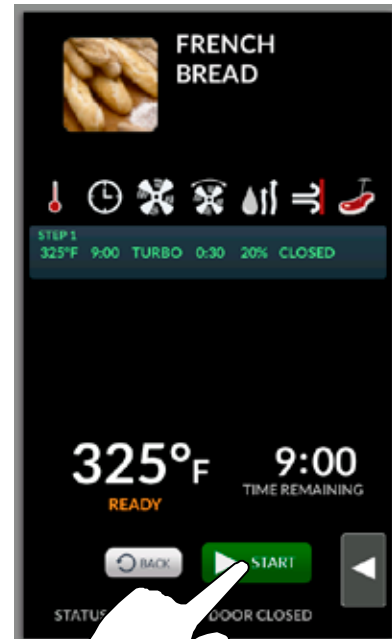

Figure 30

4. Press the FLYOUT arrow at any time to access Add a Minute, Steam on Demand or the cavity lights. Press CANCEL at any time to stop the cook cycle.

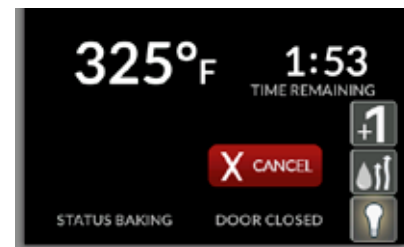

Figure 31

5. When the cook time has expired, the display flashes DONE and the alarm sounds. Press CANCEL to silence the alarm. The control returns to the recipe cook screen.
6. Press BACK to exit out of MENU mode.



# Operation

## SmartTouch 2 Touchscreen Control

### RACK TIMING

#### Creating a Rack Timing Group

1. From the mode selection screen, select RACK TIMING. The SELECT GROUP screen is displayed.
2. Select ADD GROUP.

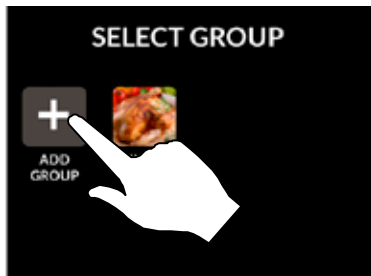

Figure 32

3. Press the pencil icons to edit the group name and cooking parameters. You may also select an icon to represent the group.
4. Enter desired cooking parameters.

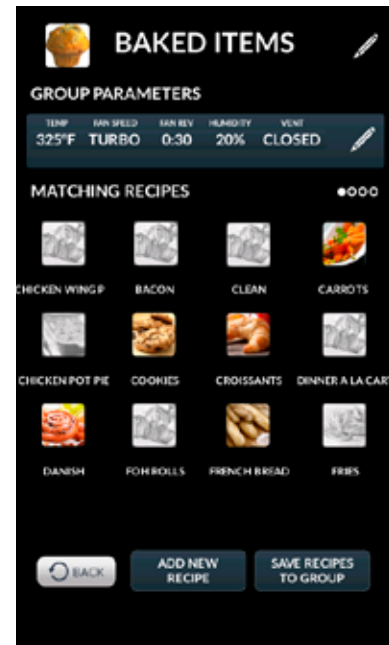

Figure 34

6. Press SAVE RECIPES TO GROUP.

#### Edit Existing Group

1. From the mode selection screen, select RACK TIMING.
2. Press and hold the icon for the group you wish to edit.
3. Choose edit, copy or delete from the pop up menu.

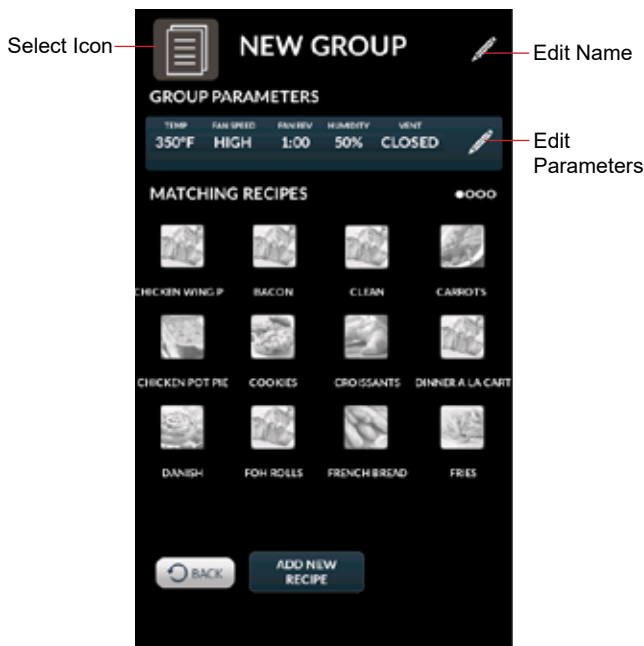

Figure 33

5. Select the recipes you would like to place in the group. Only recipes with parameters matching the group may be selected.

## SmartTouch 2 Touchscreen Control

### Using Rack Timing

1. From the mode selection screen, select RACK TIMING. The SELECT GROUP screen is displayed.
2. Select the desired food group for your product.

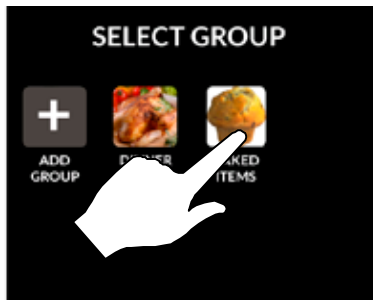

Figure 35

3. Press selected item icon at the top of the screen, drag to an open shelf. Or tap an open rack to assign the selected icon to that rack.

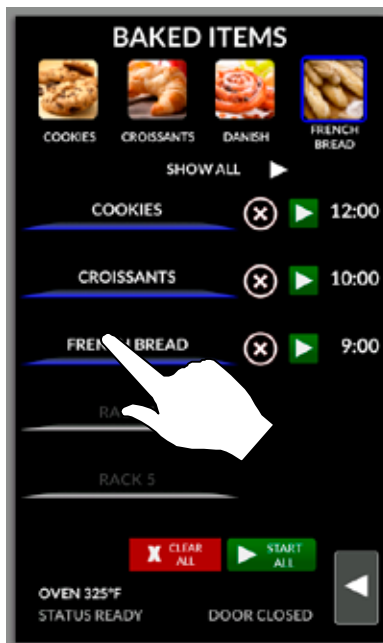

Figure 36

4. Start timers using the arrows. You can choose START ALL or start individual racks.

*NOTE: START will not be displayed until the oven has reached the programmed set temperature.*

*NOTE: If the oven is preheating or cooling down, the fan speed will automatically run in high until the oven reaches the set temperature.*

5. To add time, select +1 MIN key for individual racks or +1 MIN ALL key to add time to all racks. Each time the key is pressed, 1 minute of cook time is added.

During the cook cycle, individual rack timers will count down as the product is cooked. If you wish to cancel the bake, you can press the STOP ALL key, or you can stop individual racks.

6. Once a rack bake is complete the beeper will sound. Press STOP next to the rack that has completed the cook cycle. If all racks finish at the same time, press STOP ALL. STOP ALL.

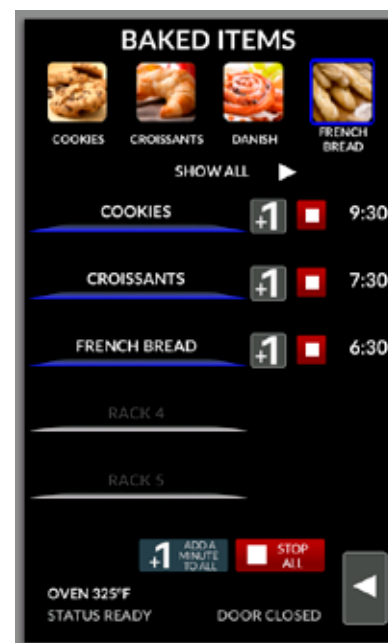

Figure 37

7. Press CLEAR ALL to escape the screen.

### To Use Timer

1. Press the FLYOUT arrow at any time to access a timer or the cavity lights.



Figure 38



# Operation

## SmartTouch 2 Touchscreen Control

### USB INTERFACE

#### To Access the USB Drive

1. From the mode selection screen, select USB



Figure 39

2. Enter the code 6647 on the keypad provided.



Figure 40

3. The following menu is displayed.



Figure 41

4. Insert USB drive into USB port on the control panel.

## SmartTouch 2 Touchscreen Control

### To Store Menu Data to a USB

*NOTE: The following procedure may be used to store any type of data to a USB including HACCP, settings and fault logs.*

1. Select STORE MENU TO USB.
2. Enter a filename for the menu data using the keypad provided. Press the disk icon to save.

*NOTE: DO NOT use spaces in the filename.*



Figure 42

3. The status screen is displayed. Press OK when the transfer is complete.

### To Retrieve Menu Data from a USB

*NOTE: The following procedure may be used to upload menu recipes and/or icons from a USB.*

1. Select LOAD MENU FROM USB.
2. Select the file to download to the oven.

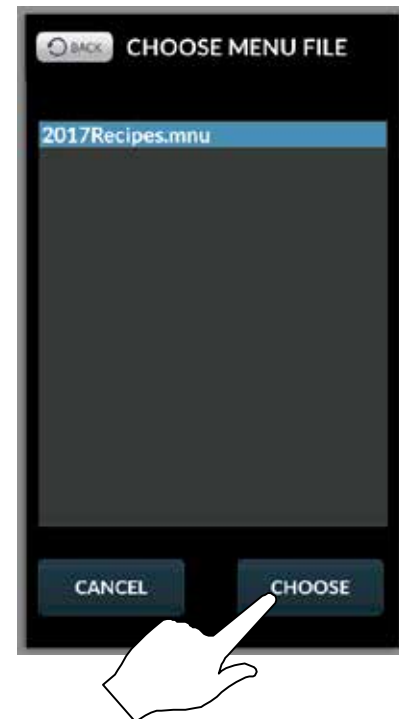

Figure 43

3. The status screen is displayed. Press OK when the transfer is complete.



# Operation

## SmartTouch 2 Touchscreen Control

### COOL DOWN

1. From the mode selection screen, select COOL DOWN.

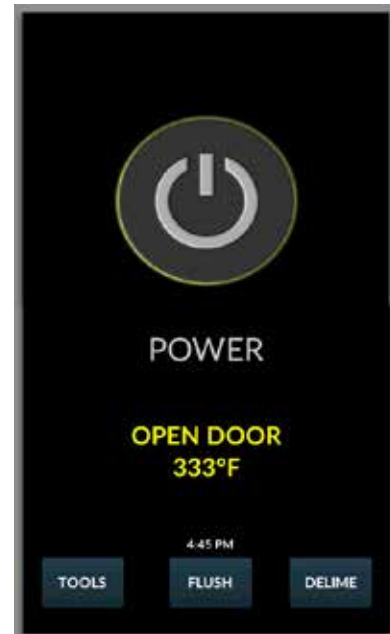

Figure 44

2. The display toggles between cooling and open door in yellow until the oven is cool.

*NOTE: If the oven is shut down with the circuit breaker switch at the bottom of the front panel, the display will return to the power screen.*

*NOTE: The vent will automatically open and the fan will run on high speed during cool down to assist in lowering the cavity temperature. The fan and vent will disengage when the oven had cooled.*



BCX shown

Figure 45





## Spray Bottle Operating Procedure

**NOTE:** Only use a commercial oven cleaner/degreaser with the spray bottle. DO NOT use chemicals that are not intended as oven cleaners. See chemical manufacturer's information for intended use.

1. Unscrew the sprayer head and fill the container to the MAX mark. Screw the head assembly on firmly to ensure an airtight seal. The liquid must be clean and free from foreign matter. Do not overfill - space must be left for compressing air.



Figure 46

2. To build up pressure, pump approximately 20 full strokes when the container is filled with liquid. The higher the pressure, the finer the spray. If the container is only partially filled, then more pumping is required to compress the additional air space.



Figure 47

3. To spray, depress the trigger with your thumb.



Figure 48

4. Adjust spray nozzle for a wide spray pattern.
5. After a period of spraying, the pressure will drop. Restore the pressure by operating the air pump.
6. Release pressure after use by inverting the spray head and depressing the trigger or by slowly unscrewing the spray head assembly which will allow air to escape from around the filling aperture.
7. After use, rinse the spray bottle with clean water and check that the hole in the nozzle is perfectly clean and clear. Warm water (not hot) used with a household detergent is a useful cleaning agent for this purpose.

**NOTE:** Further information can be found in the instruction leaflet supplied with your spray bottle.



### WARNING!!

**Protective clothing and eyewear should be worn while using cleaning and deliming agents.**

To order additional bottles or spray heads use the following part numbers:

Complete Spray Bottle - P/N R0006

Spray Head Repair Kit - P/N R6332



# Maintenance

## Cleaning and Preventive Maintenance

### DAILY CLEANING

#### Cleaning the Interior

Daily cleaning of the oven is essential for sanitation, and to ensure against operational difficulties. The stainless steel cavity may corrode with improper cleaning of the oven. Use an oven cleaning detergent in conjunction with the supplied spray bottle.

For difficult cleaning, allow the spray-on oven cleaner to work longer before rinsing.

1. Open the oven door. Place the oven in cool down mode. Let the oven cool to below 140°F (60°C).
2. Fill the spray bottle with a mild oven detergent. **DO NOT use abrasive cleaners on your Blodgett Combi. Be sure to follow the MSDS or safety instructions on the bottle of your oven cleaner.**
3. Pump the bottle twenty times to build up pressure. The higher the pressure, the finer the spray. Spray the oven interior. Turn the nozzle to adjust the spray pattern.
4. Close the door. Place the oven in steam mode for 10 minutes.
5. When finished steaming, open the door and rinse the interior with the attached spray hose.



Figure 49

6. Leave the door open overnight to vent the oven. If the oven will not be used for an extended period of time, place the oven in hot air mode to dry.



Figure 50

#### Cleaning the Exterior

The exterior of the appliance may be cleaned and kept in good condition with a light oil. Saturate a cloth and wipe the appliance when it is cold; wipe dry with a clean cloth.



#### **WARNING!!**

**DO NOT spray the outside of the oven with water or clean with a water jet. Cleaning with a water jet can impregnate chlorides into the stainless steel, causing the onset of corrosion.**

Clean the air intake / cooling fan behind the oven so that it is free of all lint, grease or other inhibitors of air flow. Keeping this area free of obstruction will extend the life of the components.

### PREVENTIVE MAINTENANCE

The best preventive maintenance measures are the proper initial installation of the equipment and a program for cleaning the appliance routinely. The Oven/Steamer requires no lubrication. Contact the factory, the factory representative or a local Blodgett Combi service company to perform maintenance and repairs should they be required.

#### WEEKLY CLEANING - BCX-14

In addition to the daily cleaning it is necessary to clean the air intakes on a weekly basis. Air intakes provide necessary cooling air to the internal components. They are generally located on the rear and sides of the equipment.



## Cleaning and Preventive Maintenance

### BX-14 BOILERLESS OVEN WEEKLY CLEANING

In addition to the daily cleaning, it is necessary to clean behind the fan guard of this oven on a weekly basis. This is necessary for proper functioning of the oven. Scale will build up on the fan and heat source leading to a less efficient oven.

1. Open the oven door. Place the oven in cool down mode. Let the oven cool to below 140°F (60°C).
2. Once cool, turn the oven off.
3. Remove the oven racks and the rack guides on the left side.



Figure 51

4. Rotate the two screws on the left side of the fan guard. Swing the fan guard toward the front of the oven.



Figure 52

5. Fill the spray bottle as described in the Daily Cleaning procedure. Thoroughly spray cleaner onto the fan, heat source and back of the fan guard. Resecure the fan guard.



Figure 53

6. Close the door. Place the oven in the steam mode for approximately 10 minutes.
7. After ten minutes, swing the fan guard towards the front of the oven. Use plenty of water to rinse all of the cleaner off.



Figure 54

8. Return the fan guard to the closed position. Rotate the two screws to secure the fan guard.
9. Reinstall the rack guides and oven racks.
10. Leave the oven door open overnight to vent the oven. If the oven will not be used for an extended period of time, place the oven in hot air mode to dry the interior cavity.



# Maintenance

## Flushing the Boiler - BCX Models Only

### STANDARD CONTROL

A flush of the boiler is required every 24 hours and happens either automatically or can be initiated at any time.

*NOTE: In order to flush the oven, the water and gas supply must be left on.*

#### To manually initiate a flush sequence

1. Either run a cool down or just open the oven door to cool the interior.

*NOTE: If the boiler water temperature is too high, the flush will start automatically when the water temperature drops below 140°F (60°C).*

2. From the power screen, press the center display key.
3. The flush completes in about 25 minutes. When complete, the oven shuts off automatically.

#### To cancel a flush sequence

1. Press the POWER KEY (1) to cancel a flush cycle.

### SMARTTOUCH 2 CONTROL

A flush of the boiler is required every 24 hours and happens either automatically or can be initiated at any time.

*NOTE: In order to flush the oven, the water and gas supply must be left on.*

- The oven will automatically initiate a flush cycle at the time listed above the flush key on the power screen.
- If the boiler is too hot to drain, the flush will begin when the boiler water temperature drops below 140°F (60°C).

#### To manually initiate a flush sequence

1. From the power screen, press FLUSH.

*NOTE: If the boiler is too hot to drain, the flush will begin when the boiler water temperature drops below 140°F (60°C).*



Figure 55

2. The control displays the current flush stage. To stop the flush cycle, press ABORT.

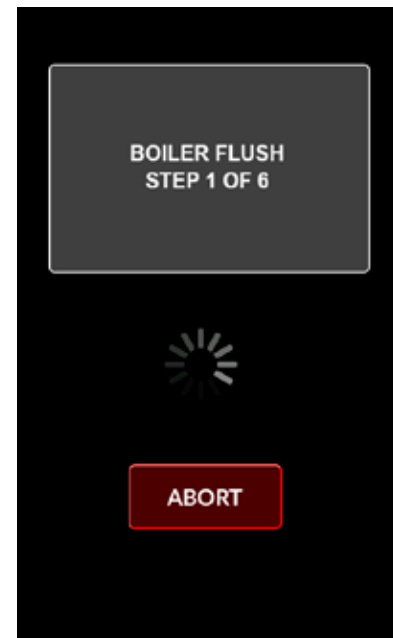

Figure 56

3. The flush completes in about 25 minutes. When complete, the control returns to the power screen.



### BCX COMBI OVENS

Deliming of the steam generator is the single most important preventative maintenance task. Lime will build up inside the steam generator, reducing efficiency and causing damage to the boiler.

**WARNING!!**

Problems caused by insufficient deliming are not covered by the warranty.

**WARNING!!**

Deliming solutions are hazardous and can cause burns to the skin and eyes. Wear protective clothing and eyewear.

**WARNING!!**

**DO NOT cook while deliming.**

1. Be sure the container delivering the deliming agent to the appliance is full. **Be sure to follow the MSDS or safety instructions on your deliming agent.** Use a non-diluted deliming agent.



Figure 57

2. Ensure that the deliming pump has been primed. Refer to the Deliming System Connection & Priming if you are uncertain.

### BCX WITH STANDARD CONTROL

1. When it is time to delime your BCX, the display reads:

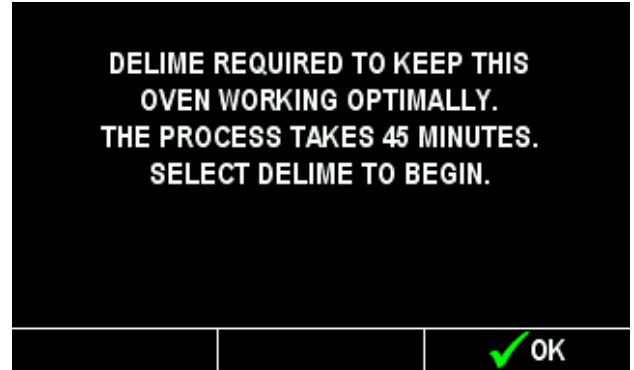

Figure 58

To postpone the delime process, press the right display key under OK.

The message will return until the unit is delimed. This is a warning only, the oven can be used all day before deliming. The delime sequence can be run at anytime.

*NOTE: Once the deliming process has been started, the oven cannot be used until deliming is complete, approximately 45 minutes.*

#### Deliming the Boiler with the Manual Control

1. If the oven is hot, place in the Cool Down mode with the door open until the cavity is below 140°F (60°C).
2. After the cool down the unit will automatically turn itself off. Close the door.
3. Press the right display key under DELIME.

The remainder of the process is automatic. The display shows the step number and progress by %.

4. When the deliming process is complete, the control will turn itself off. The oven can now be used normally.

#### To Cancel the Deliming Process

1. Press the POWER KEY (1) to cancel a flush cycle.

*NOTE: If the delime is canceled after chemical is introduced, the cancel will take longer.*



# Maintenance

## Deliming

### BCX WITH SMARTTOUCH 2 CONTROL

After 30 hours of boiler operation the control reminds you delime your boiler. Press OK to acknowledge the reminder.

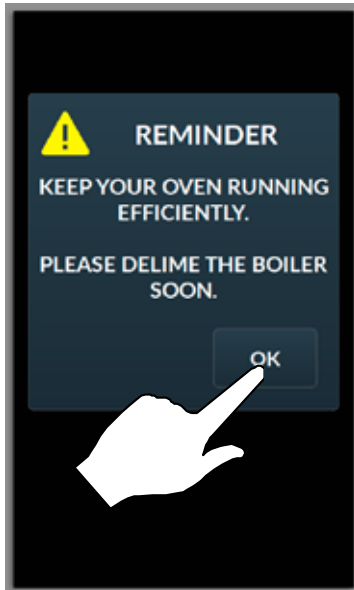

Figure 59

The message will return until the unit is delimed. This is a warning only, the oven can be used all day before deliming. The delime sequence can be run at anytime.

### Deliming the Boiler with the SmartTouch 2 Control

1. From the power screen, press DELIME.

*NOTE: If the oven is hot, place in the Cool Down mode with the door open until the cavity is below 140°F (60°C).*



Figure 60

2. The control displays the current flush stage. To stop the deliming process, press ABORT.

*NOTE: Once the deliming process has been started, the oven cannot be used until deliming is complete, approximately 45 minutes.*

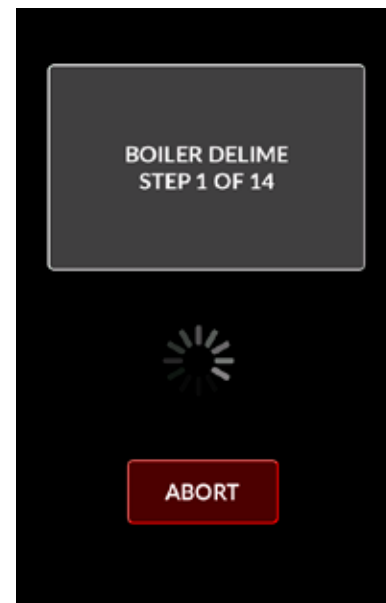

Figure 61

3. When complete, the control returns to the power screen.



### BX-14 BOILERLESS OVEN

It may be necessary to delime the oven interior and behind the fan guard. This is necessary for proper functioning of the oven. Lime will build up on the fan and heat source leading to a less efficient oven.

1. Open the oven door. Place the oven in cool down mode. Let the oven cool to below 140°F (60°C).
2. Fill the spray bottle with a non-diluted deliming agent. **Be sure to follow the MSDS or safety instructions on your deliming agent.**
3. Pump the bottle twenty times to build up pressure. The higher the pressure, the finer the spray
4. Remove the oven racks and the rack guides on the left side.



Figure 62

5. Rotate the two screws on the left side of the fan guard. Swing the fan guard toward the front of the oven.



Figure 63

6. Thoroughly spray deliming agent onto the fan, heat source and back of fan guard. Wait 10 minutes.



Figure 64

7. After ten minutes, use the spray hose and plenty of water to rinse all of the deliming agent off. Repeat steps 6 & 7 if necessary.

*NOTE: If the lime scale is hard to remove or takes multiple applications, your water filtration system may be insufficient or your filters may need to be changed.*



Figure 65

8. Return the fan guard to the closed position. Rotate the two screws to secure the fan guard.
9. Reinstall the rack guides and oven racks.
10. Leave the oven door open overnight to vent the oven. If the oven will not be used for an extended period of time, place the oven in hot air mode to dry the interior cavity.



# Maintenance

## Deliming

### DELIMING INTERVAL SETTING - BCX ONLY

Refer to figure below to determine the correct delimiting interval for your appliance. Find your location and the corresponding potentiometer setting. These values are general and are guidelines only. Your specific water quality may be harder or softer. Adjust the delimiting interval to your specific water quality.

*NOTE: If you have the oven connected to a filter system, the water hardness may be reduced. Check with filter supplier for details.*

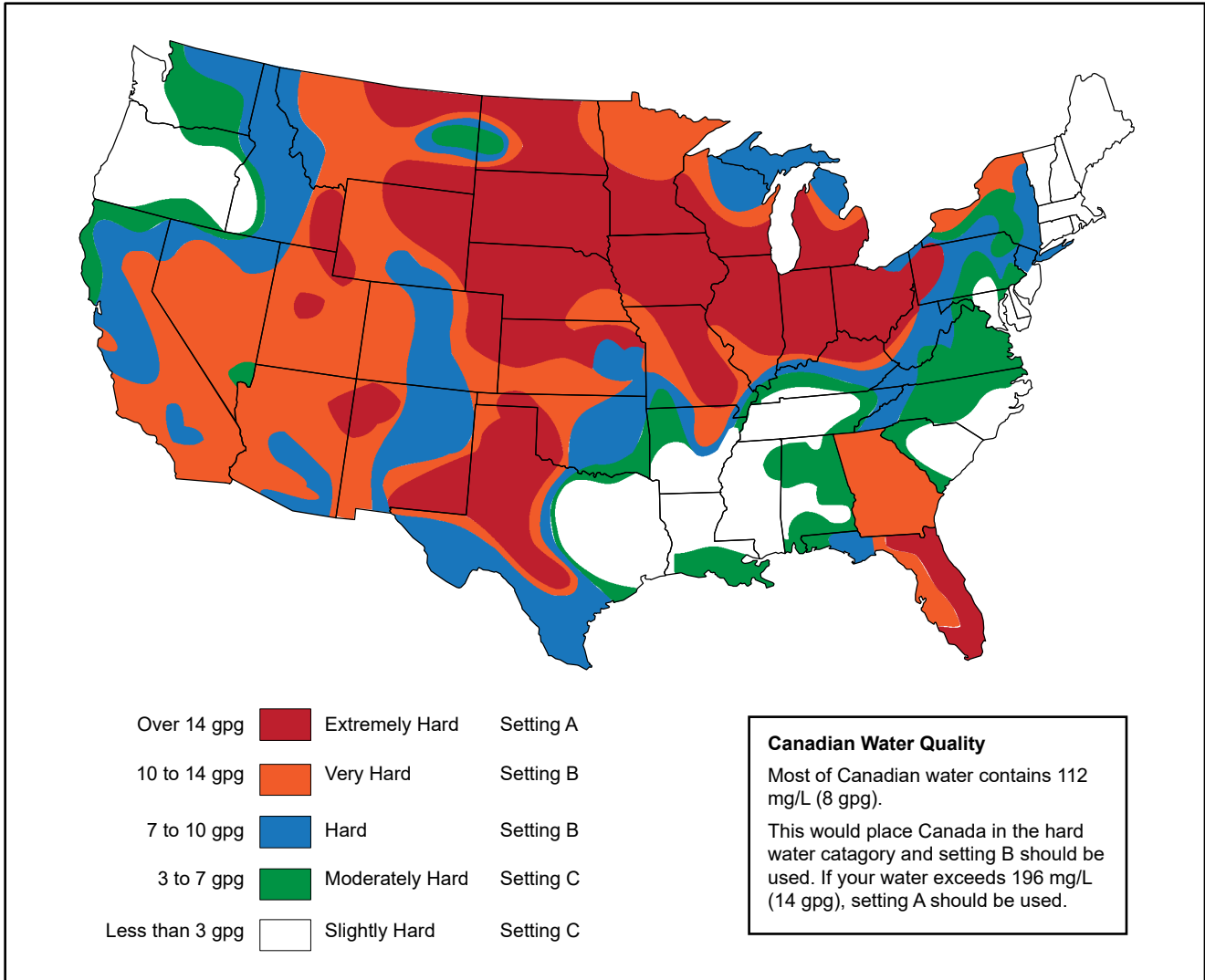

Figure 66