



IMPORTANT FOR FUTURE REFERENCE

Please complete this information and retain this manual for the life of the equipment:

Model #: _____

Serial #: _____

Date Purchased: _____

INSTALLATION & OPERATION MANUAL

Electric Steam Generator in Cabinet Base

CE-24 CE-36 CE-42 CE-4, ``CE-324 ``CE-336 ``CE-342 ``CE-348

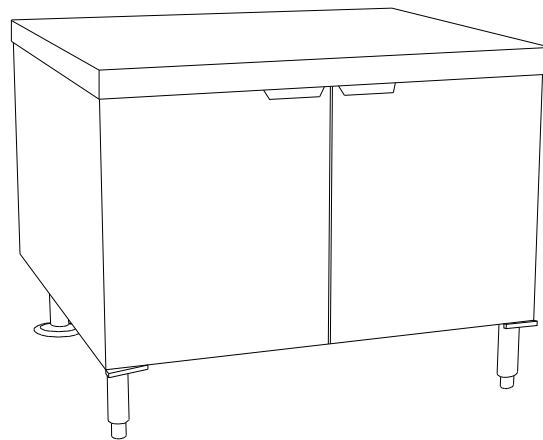

 **WARNING**

Improper installation, adjustment, alteration, service or maintenance can cause property damage, injury or death. Read the installation, operating and maintenance instructions thoroughly before installing or servicing this equipment.

CROWN FOOD SERVICE EQUIPMENT

 A Middleby Company

70 Oakdale Road, Downsview (Toronto) Ontario, Canada, M3N 1V9

Telephone: 919-762-1000 www.crownsteamgroup.com

Printed in Canada

INSTALLATION AND OPERATION MANUAL, ELECTRIC BOILERS,
CE24, CE36, CE42, CE48, CE324, CE336, CE342, CE348

IMPORTANT NOTES FOR INSTALLATION AND OPERATION

It is recommended that this manual be read thoroughly and that all instructions be followed carefully.

	<p>This is the safety alert symbol. It is used to alert you to potential personal injury hazards. Obey all safety messages that follow this symbol to avoid possible injury or death.</p>
---	--

	<p>WARNING: Improper installation, operation, adjustment, alteration, service or maintenance can cause property damage, injury or death. Read the installation, operating and maintenance instructions thoroughly before installing, operating or servicing this equipment.</p>
---	--

	<p>CAUTION: Operating, testing, and servicing should only be performed by qualified personnel.</p>
---	---

	<p>WARNING: Disconnect the power supply to the appliance before cleaning or servicing.</p>
---	---

Intended for commercial use only. Not for household use.

This manual should be retained for future reference.

INSTALLATION AND OPERATION MANUAL, ELECTRIC BOILERS,
CE24, CE36, CE42, CE48, CE324, CE336, CE342, CE348

TABLE OF CONTENTS

DESCRIPTION	PAGE
1.0 Service Connections	4
2.0 Installation Instructions	5
3.0 Operating Instructions	8
4.0 CSD-1 Optional Feature	10
5.0 Periodic Maintenance	12
6.0 Troubleshooting	15

INSTALLATION AND OPERATION MANUAL, ELECTRIC BOILERS, CE24, CE36, CE42, CE48, CE324, CE336, CE342, CE348

2.0 SERVICE CONNECTIONS

- Ⓛ - DRAIN: 2"IPS piped to open floor drain. No Solid Connection.
- Ⓛ - GENERATOR WATER: 3/8" O.D. tubing at 25-50 PSI(170-345 kPa)
- Ⓛ - COLD WATER: (Optional) for condenser.
- Ⓛ - STEAM TAKE-OFF CONNECTION: 3/4" IPS to operate adjacent equipment.
- Ⓛ - Field Wiring Electrical Connection to be as specified on data plate.

WATER QUALITY STATEMENT

Water quality is the major factor affecting the performance of your appliance. If you are unsure of water quality, consult a local water treatment specialist and have the water analyzed. Your water supply must be within these general guidelines:

Total dissolved solids	Less than 60 PPM
Total alkalinity	Less than 20 PPM
Silica	Less than 13 PPM
Chlorine	Less than 1.5 PPM
pH Factor	7.0-8.5

Water which fails to meet these standards should be treated by installation of a water conditioner.
FAILURE OR MALFUNCTION OF THIS APPLIANCE DUE TO POOR WATER QUALITY IS NOT COVERED UNDER WARRANTY.

ELECTRICAL CHARACTERISTICS

kW	PHASE	OUTPUT MAX. LBS/HR.	AMPS PER LINE					
			208V	220V	240V	380V	415V	480V
24	1	69	115.4	109.1	100.0	N/A	N/A	N/A
	3	69	66.6	62.9	57.7	36.5	33.4	28.9
36	3	107	99.9	94.5	86.6	54.7	50.1	43.3
42	3	128	116.6	110.2	101.0	63.8	58.4	50.5
48	3	148	N/A	N/A	115.5	72.9	66.8	57.7

DIMENSIONS

WIDTH	SHIPPING WT.	UNITS	A	B	C	D	E	F	G	H	J	K	L	M	N	P
24 610	350 lbs. [159 kg]	inches mm	8.75	5.75	16.75	23	8.75	3.5	10.5	2.5	11.12	2.75	2.5	13	19.75	4.75
36 914	415 lbs. [188 kg]	inches mm	222	146	425	584	222	89	267	64	283	70	64	330	502	121
							457					4.75	21.25	540		6.75
												121	540			171

MODELS

WIDTH	24 kW	36 kW	42 kW	48 kW	MIN. CLEARANCE	
24 inches 610 mm	CE-24	CE-36	CE-42	CE-48	SIDES	0
36 inches 914 mm	CE-324	CE-336	CE-342	CE-348	BACK	0

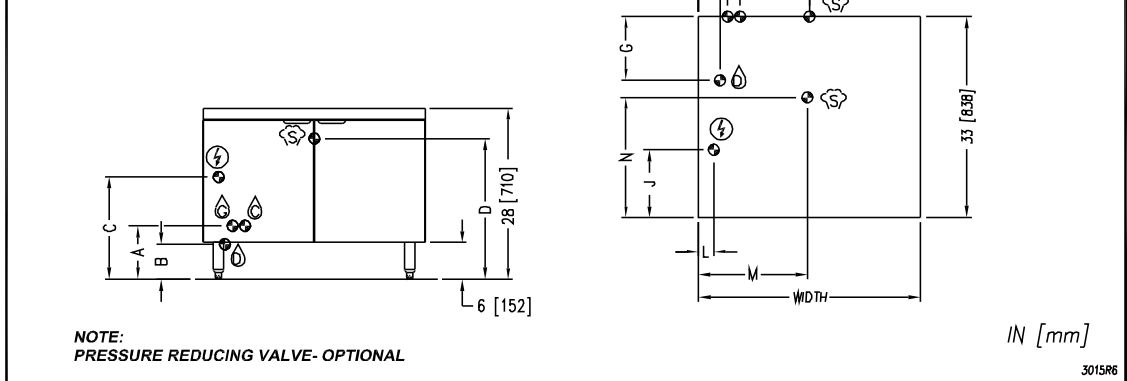

As continued product improvement is a policy of Crown, specifications are subject to change without notice.

INSTALLATION AND OPERATION MANUAL, ELECTRIC BOILERS,
CE24, CE36, CE42, CE48, CE324, CE336, CE342, CE348

2.0 INSTALLATION INSTRUCTIONS

GENERAL

The electric boiler is designed to ASME Code and approved as a steam heating boiler restricted to operation at pressure not to exceed 15 psi. Boilers are electrically rated as shown on page 4. Boiler may have optional CSD1 controls.

INSTALLATION

UNPACKING

Immediately after unpacking, check for possible shipping damage. If the appliance is found to be damaged, save the packaging material and contact the carrier within 15 days of delivery. Before installing, verify the electrical rating agrees with the specification on the rating plate.

LOCATION

Position the boiler in its installation location. Check that there are sufficient clearances to service the controls, door swing, etc. Also adequate clearance must be left for making the required supply and drain connections.

Allow enough space between any other piece of equipment or wall for service access. Service to the controls may be required on the left and/or right side panels of the cabinet.

INSTALLATION CODES AND STANDARDS

The boiler must be installed in accordance with:

In Canada:

Provincial and local codes, or in the absence of local codes, with the Canadian Electric Code, CSA C22.1 (latest edition). Copies may be obtained from the Canadian Standards Association, 178 Rexdale Blvd., Etobicoke, Ontario, Canada, M9W 1R3.

In the USA:

State and local codes, or in the absence of local codes, with the National Electrical Code, ANSI/NFPA-70 (latest edition). Copies may be obtained from The National Fire Protection Association, Batterymarch Park, Quincy, MA, USA, 02269.

INSTALLATION AND OPERATION MANUAL, ELECTRIC BOILERS,
CE24, CE36, CE42, CE48, CE324, CE336, CE342, CE348

LEVELING AND ANCHORING THE CABINET

1. Place appliance in the installation position.
2. Place a carpenter's level on top of the appliance and turn the adjustable feet to level side-to-side and front-to-back.
3. Mark hole locations on the floor through the anchoring holes provided in the rear flanged adjustable feet.
4. Remove appliance from installation position and drill holes in locations marked on the floor. (See installation diagram on page 4.) Insert proper anchoring devices (not supplied).
5. Place appliance back in the installation position.
6. Place carpenter's level on top appliance and re-level side-to-side and front-to-back.
7. Bolt and anchor appliance securely to the floor.
8. Seal bolts and flanged feet with silastic or equivalent compound.

ELECTRICAL CONNECTIONS

	WARNING: Electrical and grounding connections must comply with the applicable portions of the National Electrical Code and/or other local electrical codes.
---	--

	WARNING: Disconnect electrical power supply and place a tag at the disconnect switch to indicate you are working on the circuit.
---	---

When making electrical connections, use copper wire suitable for at least 200°F (90°C). The steamer must be grounded in accordance with the National Electrical Code or applicable local codes. The wiring diagram is located on the inside of the right panel.

INSTALLATION AND OPERATION MANUAL, ELECTRIC BOILERS,
CE24, CE36, CE42, CE48, CE324, CE336, CE342, CE348

EXHAUST HOOD

An exhaust system should be located directly above the boiler to exhaust steam and heat generated by the boiler.

PLUMBING CONNECTIONS (See Page 4)

WARNING: Plumbing connections must comply with applicable sanitary, safety, and plumbing codes.

Water Supply Connection

The incoming cold water supply connection, at the rear of the boiler cabinet, requires 3/8" tubing and water pressure of 25 - 50 psig. A manual shut-off valve must be provided convenient to the boiler; this valve should be open when the boiler is in operation.

Drain Connection

The boiler drain (2" IPS) should be piped to a floor drain near the boiler. There should be no solid drain connection; an "open gap" between the boiler and the floor drain is required.

INSTALLATION AND OPERATION MANUAL, ELECTRIC BOILERS,
CE24, CE36, CE42, CE48, CE324, CE336, CE342, CE348

3.0 OPERATING INSTRUCTIONS

For CSD-1 equipped boilers, see section 4.0 CSD-1 Optional Feature for proper operating instructions.

BOILER CONTROLS (Inside Cabinet)

- Main Power Switch - ON fills the boiler tank and turns the boiler heaters on. You should allow 20 minutes to fill the tank and generate steam.
- OFF shuts off the boiler heaters and opens the Automatic Blowdown Valve, emptying the boiler tank and releasing water and steam to the drain. This should be done daily to remove sediment, lime, or scale.
- Pilot Light - Indicates main power is ON.
- Boiler Pressure Gauge - Should read 9 - 11 psig during operation; 0 psig during shutdown.
- Water Level Sight Glass- Observe level of water and water quality in the boiler. Murkiness in the water indicates inadequate water quality; the owner must supply proper water to the boiler (see page 4).
- Water Level Control - While boiler is ON, briefly open the water level control valve once a day to remove any sediment that might accumulate. (See page 12 for detailed instructions.)
- Safety Valve - This valve will release (pop off) if the boiler has too much pressure. Once a week, this valve should be tripped during operation to make sure it functions properly.

OPERATION OF THE BOILER

Turn on water and power supply.

Open cabinet door and turn main power switch ON. Pilot light ignites and water begins to fill boiler - observe water gauge sight glass to verify that proper water level is reached.

Once the proper water level is reached, the heaters begin to heat the water. Heaters require about 15 minutes to begin steam generation. The boiler pressure gauge in the cabinet should indicate steam pressure in a range of 9 to 11 psig.

INSTALLATION AND OPERATION MANUAL, ELECTRIC BOILERS,
CE24, CE36, CE42, CE48, CE324, CE336, CE342, CE348

3.0 OPERATING INSTRUCTIONS (Continued)

SHUT DOWN

Turn the Main Power Switch OFF: Open manual drain valve. If unit is supplied with Automatic Blowdown Valve, it will open, draining the boiler and releasing hot water and steam to the drain.

INSTALLATION AND OPERATION MANUAL, ELECTRIC BOILERS,
CE24, CE36, CE42, CE48, CE324, CE336, CE342, CE348

4.0 CSD-1 OPTIONAL FEATURE

OPERATING, TESTING, SERVICING AND CLEANING INSTRUCTIONS

Start-up Procedure

1. Close the manual blowdown valve.
2. Open cabinet door and turn "ON" power switch.

The green pilot light will come "ON." Water will begin to enter the boiler. When enough water has entered the boiler, the (amber) "STANDBY" pilot light will come on.

3. Press the "RESET" switch to begin boiler operation.
The "STANDBY" pilot light will go off and the boiler will begin operation.

Normal Boiler Operating Cycle

Water Fill Cycle

On the initial filling of the boiler, the reset switch must be activated to initialize the safety lockout circuit. Once the water in the boiler has reached the proper level, the level control will stop the flow of water to the boiler. As water is consumed in the production of steam, the level control will supply additional water to the boiler.

Firing Cycle

The elements are operated by pressure sensing devices. On initial operation, the boiler should reach 14 psi in approximately 15 minutes. At this point, the operating pressure switch will open, de-energizing the elements. Thereafter the operating pressure switch will cycle the elements between 9 and 11 psi boiler pressure.

Condensing Drain

A thermostat is located in the drain assembly and is activated by the temperature of steam. The thermostat operates the cooling solenoid, supplying water to the drain to condense the steam.

Automatic Blowdown Valve

If the unit has an automatic blowdown valve, it is activated when the main power switch is activated. The boiler will be drained should the main power switch be turned "OFF."

INSTALLATION AND OPERATION MANUAL, ELECTRIC BOILERS,
CE24, CE36, CE42, CE48, CE324, CE336, CE342, CE348

SAFETY LOCKOUT CONDITIONS

High Temperature Condition

A high temperature safety device is installed on the boiler. Should the temperature exceed the limit of this device, the boiler will be shut down and put in a state of lockout. The "TEMPERATURE" pilot light (red), and the "STANDBY" pilot light (amber), will come on.

High Pressure Condition

A high pressure safety switch is installed on the boiler. Should the pressure exceed the limit of this device, the boiler will be shut down and put into a state of lockout. The "PRESSURE" pilot light (red), and the "STANDBY" pilot light (amber), will come on. Should this device fail to operate, the safety relief valve will open.

Low Water Condition

A second low water safety cut off is supplied with the boiler. Should the water level fall below normal operating levels, the boiler will be shut down and put into a state of lockout. The "LOW WATER" pilot light (red), and the "STANDBY" pilot light (amber) will come on.

INSTALLATION AND OPERATION MANUAL, ELECTRIC BOILERS,
CE24, CE36, CE42, CE48, CE324, CE336, CE342, CE348

5.0 PERIODIC MAINTENANCE

Be sure to flush your boiler water level control daily. Failure to follow this procedure can cause the control to malfunction resulting in serious boiler damage.

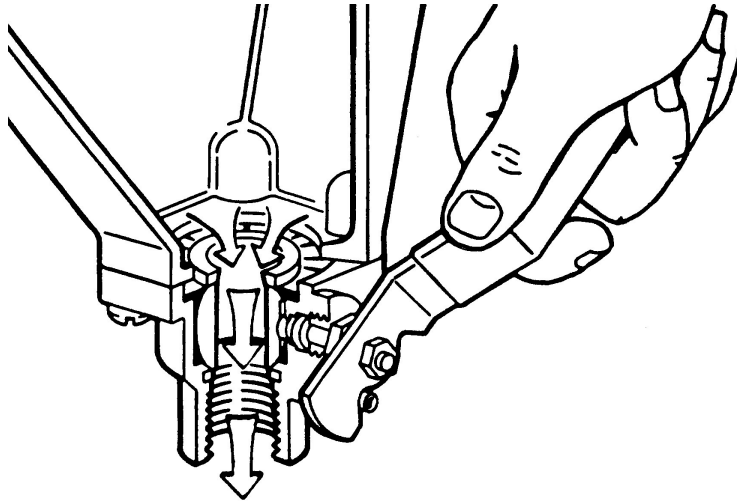

The Boiler Water Level Control installed on your boiler requires periodic maintenance. As boiler water circulates into the float chamber, sand, scale and other sediment may be deposited in the float chamber. While the chamber has been designed with a large accumulation bowl, it is necessary to flush the sediment from the chamber by blowing down the control so that the accumulation of sediment does not interfere with the movement of the float in the control. Control must be flushed at least once a day.



CAUTION: Protect yourself. When flushing control, hot water and steam will flow out of the drain.

When flushing control, note water level in gauge glass, allow the boiler to fill if necessary, and also to come up to temperature.

Before flushing control, note that water level in gauge glass is within operating range and the boiler pressure is at least 6 psi. While the boiler is being fired, open blowdown valve at bottom of control by rotating the handle counterclockwise about 1/4 turn to fully open the valve. Opening the blowdown valve also checks the cut-off operation. Float should drop shutting elements off, hot water and steam will flow out the drain flushing away sediment.

INSTALLATION AND OPERATION MANUAL, ELECTRIC BOILERS,
CE24, CE36, CE42, CE48, CE324, CE336, CE342, CE348

PERIODIC MAINTENANCE (Continued)

CAUTION: If heater does not shut off during blowdown, immediately discontinue use of appliance and call for service.

Continue draining water for about fifteen (15) seconds, from control until water is clean. Manually close valve. Recheck gauge glass. If water level has dropped significantly, wait for the boiler to restore water level and pressure and repeat if necessary.

1. Observe that the water in gauge glass is clean and clear. Extreme murkiness in water indicates inadequate water quality.
2. Safety valve should be tripped during operation once a week to assure that it functions properly.
3. Keep all exposed cleanable areas of unit clean at all times.



CAUTION: Take extra caution when blowing down water level control or tripping safety valve as extreme hot water and live steam are present.

DESCALING BOILER

It is recommended that the boiler be checked every 90 to 120 days for scale build up. Regular maintenance should be carried out at this time.

1. With boiler empty, close manual blowdown valve. If appliance is equipped with Automatic Blowdown, turn water supply to appliance OFF. Turn power switch ON. This will energize and close blowdown valve.
2. Remove 3/4" pipe plug from Brass Tee on front top of boiler.
3. Insert appropriate hose or tube through fitting and pour in (1/2) half gallon (U.S.) of CLR Descaling Solution.

If available, use the Optional Deliming assembly DPA-1 available from your dealer.

INSTALLATION AND OPERATION MANUAL, ELECTRIC BOILERS,
CE24, CE36, CE42, CE48, CE324, CE336, CE342, CE348

DESCALING BOILER (Continued)

4. Replace 3/4" pipe plug securely.
5. Open water supply to appliance allowing water to fill boiler to required level.
6. Let appliance cycle, allow two hours for descaling and cleaning. **DO NOT TURN ON STEAM** to attached appliances or to upper compartment.
7. Open both the blowdown and low water level control valves for complete drainage. After boiler drains, close both valves.
8. Turn appliance switch ON. When boiler is completely filled turn power switch OFF. This will rinse and drain boiler. Appliances with manual blowdown valve must be opened to drain.
9. Complete Step 8 twice to assure boiler is completely rinsed.
10. Appliance is now ready for use.

6.0 TROUBLESHOOTING

At least twice a year have an authorized service person clean and adjust the unit for maximum performance.

Water not being supplied to boiler

1. Water supply is "OFF".
2. Defective water fill solenoid.
3. Water level control clogged or defective, unable to operate fill valve.
4. Check drain valve is closed.
5. Supply water pressure too low.

Automatic blowdown valve does not drain

1. Defective blowdown valve.
2. Heat exchanger build up of scalant clogging drain lines and valve.

Boiler achieves pressure slower than normal

1. Heavy build up of lime on elements.
2. Loose element connections.

Safety valve blows

1. Defective safety valve.
2. Pressure too high, pressure switch requires adjustment (lower) or may be defective.