



IMPORTANT FOR FUTURE REFERENCE
Please complete this information and retain this manual for the life of the equipment:

Model #: _____
Serial #: _____
Date Purchased: _____

INSTALLATION & OPERATION MANUAL

Self Generating Steam Jacketed Counter Tilting Kettles EC - 6TW-2 EC - 10TW-2 EC - 12TW-2

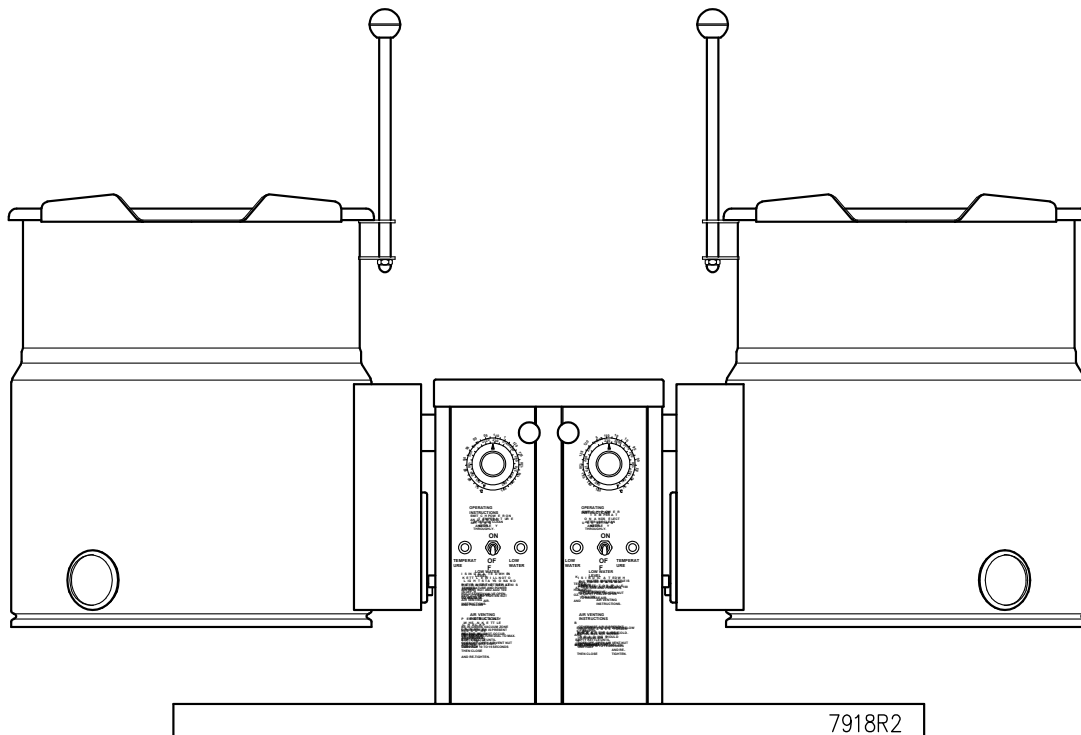

WARNING

Improper installation, adjustment, alteration, service or maintenance can cause property damage, injury or death. Read the installation, operating and maintenance instructions thoroughly before installing or servicing this equipment.

CROWN FOOD SERVICE EQUIPMENT

 A Middleby Company

70 Oakdale Road, Downsview (Toronto) Ontario, Canada, M3N 1V9
Telephone: 919-762-1000 www.crownsteamgroup.com

Printed in Canada



INSTALLATION AND OPERATION MANUAL, SELF-GENERATING STEAM JACKETED
COUNTER TILTING KETTLES, MODELS: EC-6TW-2, EC-10TW-2, EC-12TW-2

TABLE OF CONTENTS

DESCRIPTION	PAGE
SAFETY	3
SERVICE CONNECTIONS	4
1.0 INSTALLATION INSTRUCTIONS	5
2.0 INTRODUCTION	7
3.0 OPERATION INSTRUCTIONS	8
4.0 CLEANING INSTRUCTIONS	10
5.0 TROUBLESHOOTING	11
MATERIAL SAFETY DATA SHEET	13

INSTALLATION AND OPERATION MANUAL, SELF-GENERATING STEAM JACKETED
COUNTER TILTING KETTLES, MODELS: EC-6TW-2, EC-10TW-2, EC-12TW-2

IMPORTANT NOTES FOR INSTALLATION AND OPERATION

This manual should be read thoroughly and all instructions followed carefully.

Do not attempt to operate this unit in the event of a power failure.

Keep the appliance area free and clear from combustibles.

Do not obstruct the flow of combustion and ventilation air.

Adequate clearances must be maintained for servicing and proper operation.



This is the safety alert symbol. It is used to alert you to potential personal injury hazards. Obey all safety messages that follow this symbol to avoid possible injury or death.



WARNING: Improper installation, operation, adjustment, alteration, service or maintenance can cause property damage, injury or death. Read the installation, operating and maintenance instructions thoroughly before installing, operating or servicing this equipment.

This manual should be retained for future reference.

INSTALLATION AND OPERATION MANUAL, SELF-GENERATING STEAM JACKETED COUNTER TILTING KETTLES, MODELS: EC-6TW-2, EC-10TW-2, EC-12TW-2

SERVICE CONNECTIONS

- ⚡ - Electrical connection to be as specified on data plate.
- 💧 - COLD WATER: Compression fitting for 5/8 O.D. copper tubing or 1/2 NPSM male.
- 🔥 - HOT WATER: Compression fitting for 5/8 O.D. copper tubing or 1/2 NPSM male.

ELECTRICAL CHARACTERISTICS

MODEL	kW	PHASE	AMPS PER LINE						
			208V	220V	240V	380V	415V	480V	600V
EC-6TW-2	15	1	72.0	68.2	62.6	N/A	N/A	N/A	N/A
		3	41.6	39.4	36.2	22.8	20.8	18.0	14.4
EC-[10,12]TW-2	24	3	66.6	63.0	57.8	36.6	33.4	29.0	23.0

MODEL	CAPACITY	UNITS	A	B	C	D	E	F	G	H	J	K	L
EC-6TW-2	6 gallons	inches	12	14.38	24	33.5	15.25	44.38	4.50	27	4.25	12.38	10
	23 litres	mm	305	365	610	851	387	1127	114	686	108	314	254
EC-10TW-2	10 gallons	inches	16	15	26	34.88	17.25	55.25	4.62	28	6.12	14.75	12.75
	38 litres	mm		381	660	886			117	711			324
EC-12TW-2	12 gallons	Inches	406	17	28	36.88	438	1400	4.12	30	156	375	12.75
	45 litres	mm		432	711	937			105	762			324

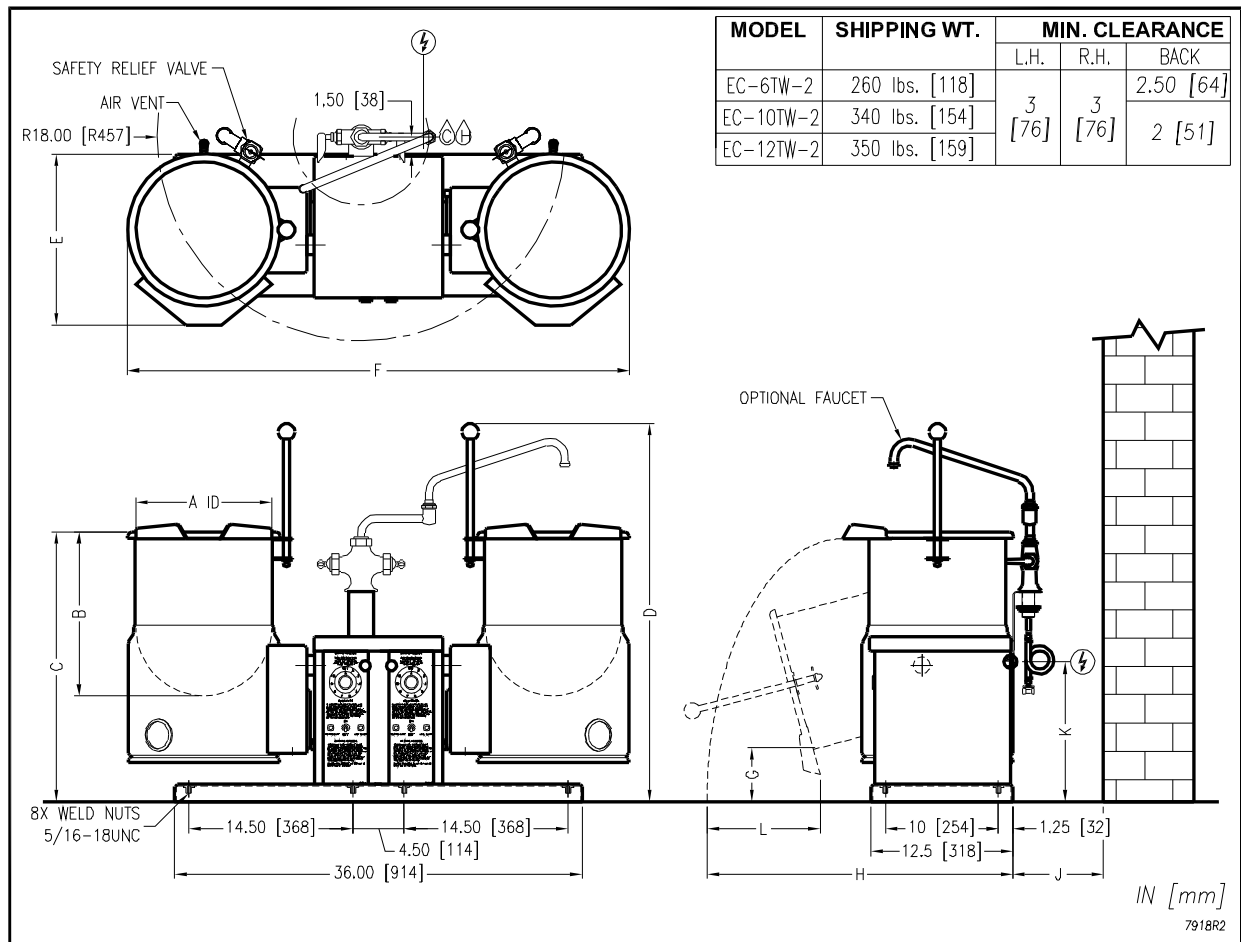

As continued product improvement is a policy of Crown, specifications are subject to change without notice.

INSTALLATION AND OPERATION MANUAL, SELF-GENERATING STEAM JACKETED
COUNTER TILTING KETTLES, MODELS: EC-6TW-2, EC-10TW-2, EC-12TW-2

1.0 INSTALLATION INSTRUCTIONS

Immediately after unpacking, check for possible shipping damage. If the kettle(s) is found to be damaged, save the packaging materials and contact the carrier within 7 days of delivery.

1. The kettle must be installed in accordance with:
 1. State and/or local codes.
 2. In the USA, the National Electrical Code, ANSI/NFPA-70 (latest edition). In Canada, the Canadian Electrical Code, Part 1, CSA Standard C22.1 (latest edition).
2. Position appliance on counter allowing sufficient rear clearance from wall to tilt freely and completely without obstruction.
3. Mark four corner locations of appliance base.
4. Remove appliance from counter and locate position of 4 holes as per Figure 1. Drill four 7/16" diameter holes.
5. Apply a continuous bead of Silastic or other equivalent sealant along the complete perimeter edge of the appliance base.
6. Use 5/16-18 Hex Cap Screws with suitable flat washers to bolt down. Screw length must be 1-1/4 long plus counter top thickness.
7. Wipe off excess sealant.
8. A Control Box with power supply equivalent to Electrical Rating of appliance should be located conveniently nearby.



WARNING: Electrical and grounding connections must comply with the applicable portions of the National Electrical Code and/or other local electrical codes.

INSTALLATION AND OPERATION MANUAL, SELF-GENERATING STEAM JACKETED
COUNTER TILTING KETTLES, MODELS: EC-6TW-2, EC-10TW-2, EC-12TW-2

1.0 **INSTALLATION INSTRUCTIONS** (Continued)

	WARNING: Disconnect electrical power supply and place a tag at the disconnect switch to indicate you are on the circuit.
---	---

9. A waterproof electrical connection from power supply to console housing must be provided.
10. Ground appliance to terminal provided inside console housing.
11. Turn power ON and check for proper operation.

FIGURE 1

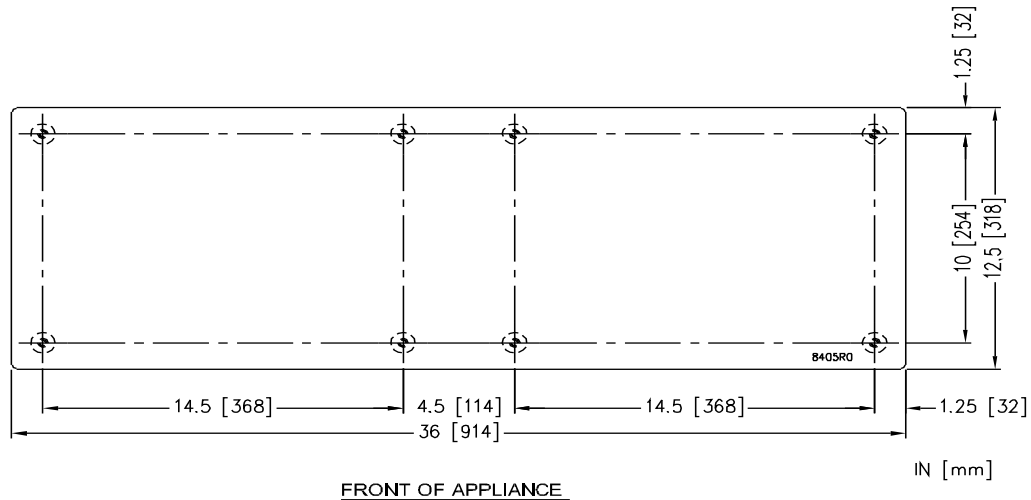

INSTALLATION AND OPERATION MANUAL, SELF-GENERATING STEAM JACKETED
COUNTER TILTING KETTLES, MODELS: EC-6TW-2, EC-10TW-2, EC-12TW-2

2.0 INTRODUCTION

DESCRIPTION

Models EC-6TW-2 (6 gallon capacity) and EC-10TW-2 (10 gallon capacity) and EC-12TW-2 (12 gallon capacity) electrically powered, self-contained, countertop, tilting kettles. Each model has a jacket of double-wall construction forming a sealed reservoir around the lower two-thirds of the kettle. The reservoir is charged with distilled water. Kettles are equipped with a removable electric heating element and controls, including a low water cutoff device for protection of the heating element. All models are of identical construction, except for kettle size and element heating capacity.

BASIC FUNCTION

Self-contained kettles operate by generating steam in the kettle reservoir. The sequence of operation is as follows:

1. Operator turns the power switch to the ON position and sets the temperature control dial to the desired temperature setting.
2. Control circuit is normally completed to the temperature controller if the following conditions exist:
 1. Water level in the kettle reservoir is adequate to prevent circuit interruption by the low water cut-off device. An activated cut-off is indicated by the amber low water light turning on, and the heating element shutoff.
 2. Kettle is in vertical position with circuit completed through the tilt interlock switch.
3. Thermostat control contacts close to energize contactor coils.
4. Power is supplied to the elements through closed power contactors.
5. As the temperature of water rises in the kettle reservoir, increase in steam pressure is indicated on the pressure gauge.
6. When the temperature of steam in the reservoir reaches the setting of the temperature control dial, the temperature controller opens to break the contacts and shuts off the heating element. On/off cycles will occur as required to maintain temperature setting.

INSTALLATION AND OPERATION MANUAL, SELF-GENERATING STEAM JACKETED
COUNTER TILTING KETTLES, MODELS: EC-6TW-2, EC-10TW-2, EC-12TW-2

3.0 OPERATION INSTRUCTIONS

1. Ensure that the external electrical shut-off to the kettle is on.
2. Check pressure gauge for correct cold kettle reading. Reading should be in the green vacuum zone. If reading is not in the vacuum zone, follow VENTING INSTRUCTION prior to using the kettle.
3. Place power switch in ON position.
4. Preheat the kettle by placing thermostat knob at maximum and wait until TEMPERATURE light goes off.

NOTE: Preheating should not be used when cooking milk and egg food products which adhere to hot cooking surfaces. These foods should be placed into kettle before heating is begun.

5. Add food to be cooked into the kettle.
6. Place thermostat knob at required temperature setting with a temperature range from roughly 165°F to 289°F (74° C to 143° C, jacket temperature.)
7. When cooking is finished set thermostat knob and power switch to the OFF position.
8. Pour finished product from kettle using tilt handle. Be careful to avoid splashing.
9. Add water to kettle for cleaning purposes.
10. Wash kettle thoroughly. See CLEANING procedure.

INSTALLATION AND OPERATION MANUAL, SELF-GENERATING STEAM JACKETED
COUNTER TILTING KETTLES, MODELS: EC-6TW-2, EC-10TW-2, EC-12TW-2

3.0 OPERATION INSTRUCTIONS (Continued)

TILTING INSTRUCTIONS

Your kettle has the standard “Clean Lock” feature and may not be tilted without disengaging the tilt knob located on the console at the top right. This feature locks the kettle in the upright position and also allows the operator to lock the kettle at 105 degrees for ease of cleaning. To tilt the kettle the full distance, the tilt lock knob must be disengaged from the cleaning position by pulling out the tilt lock knob and tilting the kettle forward the full distance. Follow these steps to tilt kettle:

1. Pull out the tilt knob near top right of console.
2. Using kettle tilt handle pull kettle forward to desired angle of pour or until kettle locks at 105 degrees. The tilt knob can be released after the kettle has been tilted approximately 10°.
3. Kettle will lock in position at 105 degrees and may be tilted further by pulling the tilt lock knob a second time allowing the kettle to tilt the full distance.
4. To return the kettle to the upright position, pull out the tilt lock knob and tilt the kettle upward until it locks in the upright position. The kettle should not move in either direction once in the upright position.

INSTALLATION AND OPERATION MANUAL, SELF-GENERATING STEAM JACKETED
COUNTER TILTING KETTLES, MODELS: EC-6TW-2, EC-10TW-2, EC-12TW-2

4.0 CLEANING INSTRUCTIONS

The kettle interior and exterior should be thoroughly washed after each use in preparation of a different food.

1. Add water and mild detergent to the kettle immediately after use.
2. Scrub kettle interior with nylon brush.

NOTE: Never scrape the inside of the kettle with metal tools, steel scouring pads, or abrasive cleaners. Scratches will result which will spoil the kettle's general appearance and make it harder to clean and maintain a sanitary condition.

3. Loosen food which is stuck to kettle by allowing it to soak at a low temperature setting.
4. Rinse with clear water and dry.



WARNING: Do not hose down appliance under any condition. Failure to comply will void warranty.

5. Wipe down exterior, rinse and dry.



WARNING: It is NOT RECOMMENDED to use cleaning agents that are corrosive.

Use of cleaning agents that contain chloride, acids or salts are corrosive and may cause pitting and corrosion when used over a period of time; this will reduce the life of the appliance.

Should pitting or corrosion occur this is not covered by warranty.

Follow the recommended cleaning instructions. Use a mild detergent, warm water and rinse thoroughly.

INSTALLATION AND OPERATION MANUAL, SELF-GENERATING STEAM JACKETED
COUNTER TILTING KETTLES, MODELS: EC-6TW-2, EC-10TW-2, EC-12TW-2

5.0 TROUBLESHOOTING

5.1 GENERAL MAINTENANCE

No general maintenance is required other than adhering to the Cleaning Procedure Instructions.

5.2 LOW WATER LEVEL

Proper water level must be maintained within the jacket for the kettle to operate. Depletion of water may occur from excessive opening of, or leakage through the safety relief valve.

If water is below required operating level, either initially at start-up or during use, the kettle will automatically shut off, and the LOW WATER signal light will come on.

In order for the kettle to operate, the following procedure must be followed:



1. Trip the safety relief valve lever to relieve all pressure from the kettle jacket.
2. At exterior rear of kettle jacket remove nut from Air Vent.
3. Insert funnel into Air Vent opening and slowly add the indicated amount of distilled water for:
EC-6TW-2 Add 50 oz. (1.5 litres)
EC-10TW-2 and EC-12TW-2 Add 100 oz. (3 litres)
4. Replace Air Vent nut.
5. Follow Air Venting Instructions below.
6. Continue normal Operating Procedure of kettle.

5.3 VENTING INSTRUCTION

Check pressure gauge when kettle is cold. Gauge should be in the green vacuum zone. If not, air is present which must be vented (removed) for proper heating. Use the following procedures to vent air.

1. With an empty kettle, place power switch to the ON position.
2. Set temperature control thermostat to maximum. Heat kettle until heat indicator light goes off.
3. Using a 7/16" wrench, open bleed vent one full turn for 10 seconds and then close.
4. Cool kettle. Check for proper vacuum in the green vacuum zone. If reading is not low enough, repeat entire procedure, steps 1 to 3.

SAFETY VALVE MAINTENANCE AND TESTING

	<p>CAUTION! Under normal operating conditions a “try lever test” should be performed every two months. Under severe service conditions, or if corrosion and/or deposits are noticed within the valve body, testing must be performed more often. A “try lever test” should also be performed at the end of any non-service period.</p>
	<p>CAUTION! Hot, high pressure fluid may be discharged from body drain and vent during “try lever” test. Care must be taken to avoid any bodily contact.</p>
	<p>CAUTION! High sound levels may be experienced during “try lever” test. Wear proper safety equipment and exercise extreme care! Test at, or near, half of the operating pressure by holding the test lever fully open for at least two seconds to flush the valve seat free of sediment and debris. Then release lever and permit the valve to snap shut.</p> <p>If lift lever does not activate, or there is no evidence of discharge, turn off equipment immediately and contact a licensed contractor or qualified service personnel.</p>

INSTALLATION AND OPERATION MANUAL, SELF-GENERATING STEAM JACKETED
COUNTER TILTING KETTLES, MODELS: EC-6TW-2, EC-10TW-2, EC-12TW-2

MATERIAL SAFETY DATA SHEET

PREPARATION INFORMATION:

Prepared for use in Canada by: E H & S Product Regulatory Management Department
DOW CHEMICAL CANADA INC.
P.O. Box 1012
Sarnia, Ontario, N7T 7K7

(800) 331-6451

1. CHEMICAL PRODUCT AND COMPANY IDENTIFICATION

IN CASE OF EMERGENCY: Fort Saskatchewan, Alberta: (780) 998-8282
Sarnia, Ontario: (519) 339-3711
Varenes, Quebec: (450) 652-1000

Product: **DOWFROST™ HD HEAT TRANSFER FLUID, DYED**
Product Code: 04632
Effective Date: 2/20/01 Date Printed: 07/10/02 MSD: 002239

DOW CHEMICAL CANADA INC.
P.O. Box 1012
Sarnia, Ontario
Canada, N7T 7K7

24-Hour Emergency Phone Number (USA): (989) 636-4400

Product: **DOWFROST™ HD HEAT TRANSFER FLUID, DYED**
Product Code: 04632
Effective Date: 08/03/04 Date Printed: 08/04/04 MSD: 002239

The DOW CHEMICAL COMPANY, Midland, MI, USA, 48674

Customer Information Center: 800-258-2436

2. COMPOSITION/INFORMATION ON INGREDIENTS

Propylene Glycol	CAS # 000057-55-6	94%
Dipotassium Phosphate	CAS # 007758-11-4	<5%
Deionized Water	CAS # 007732-18-5	<5%

™ indicates a trademark of The Dow Chemical Company.

INSTALLATION AND OPERATION MANUAL, SELF-GENERATING STEAM JACKETED
COUNTER TILTING KETTLES, MODELS: EC-6TW-2, EC-10TW-2, EC-12TW-2

MATERIAL SAFETY DATA SHEET

Product: DOWFROST™ HD HEAT TRANSFER FLUID, DYED

Product Code: 04632

Effective Date: 08/03/04, Date Printed: 08/04/04, MSD: 002239

3. HAZARDS IDENTIFICATION

EMERGENCY OVERVIEW

Clear yellow liquid. Odourless. Avoid temperatures above 450°F, 232°C.
--

POTENTIAL HEALTH EFFECTS (See Section 11 for toxicological data.)

EYE: May cause slight transient (temporary) eye irritation. Corneal injury is unlikely. Mists may cause eye irritation.

SKIN CONTACT: Prolonged contact is essentially nonirritating to skin. A single prolonged exposure is not likely to result in the material being absorbed through skin in harmful amounts. Repeated exposures may cause flaking and softening of skin.

INGESTION: Single dose oral toxicity is considered to be extremely low. No hazards anticipated from swallowing small amounts incidental to normal handling operations.

INHALATION: At room temperature, vapours are minimal due to physical properties. Mists may cause irritation of upper respiratory tract (nose and throat).

SYSTEMIC (OTHER TARGET ORGAN) EFFECTS: Repeated excessive exposure to propylene glycol may cause central nervous system effects.

CANCER INFORMATION: Did not cause cancer in laboratory animals.

TERATOLOGY (BIRTH DEFECTS): Birth defects are unlikely. Exposures having no adverse effects on the mother should have no effect on the fetus.

REPRODUCTIVE EFFECTS: In animal studies, has been shown not to interfere with reproduction.

™ indicates a trademark of The Dow Chemical Company.

INSTALLATION AND OPERATION MANUAL, SELF-GENERATING STEAM JACKETED
COUNTER TILTING KETTLES, MODELS: EC-6TW-2, EC-10TW-2, EC-12TW-2

MATERIAL SAFETY DATA SHEET

Product: **DOWFROST™ HD HEAT TRANSFER FLUID, DYED**

Product Code: 04632

Effective Date: 08/03/04, Date Printed: 08/04/04, MSD: 002239

4. FIRST AID

EYES: Flush eyes with plenty of water.

SKIN: Wash off in flowing water or shower.

INGESTION: No adverse effects anticipated by this route of exposure incidental to proper industrial handling.

INHALATION: Remove to fresh air if effects occur. Consult a physician.

NOTE TO PHYSICIAN: No specific antidote. Supportive care. Treatment based on judgment of the physician in response to reactions of the patient.

5. FIRE FIGHTING MEASURES

FLAMMABLE PROPERTIES

FLASH POINT: 214°F, 107°C (based on a similar material)

METHOD USED: PMCC

AUTOIGNITION TEMPERATURE: Not determined.

FLAMMABILITY LIMITS

LFL: Not determined.

UFL: Not determined.

™ indicates a trademark of The Dow Chemical Company.

INSTALLATION AND OPERATION MANUAL, SELF-GENERATING STEAM JACKETED
COUNTER TILTING KETTLES, MODELS: EC-6TW-2, EC-10TW-2, EC-12TW-2

MATERIAL SAFETY DATA SHEET

Product: DOWFROST™ HD HEAT TRANSFER FLUID, DYED

Product Code: 04632

Effective Date: 08/03/04, Date Printed: 08/04/04, MSD: 002239

HAZARDOUS COMBUSTION PRODUCTS: During a fire, smoke may contain the original material in addition to unidentified toxic and/or irritating compounds. Hazardous combustion products may include and are not limited to carbon monoxide and carbon dioxide.

OTHER FLAMMABILITY INFORMATION: Violent steam generation or eruption may occur upon application of direct water stream to hot liquids. Flammable concentrations of vapour can accumulate at temperatures above 214°F. Liquid mist of this product can burn. Spills of these organic liquids on hot fibrous insulations may lead to lowering of the autoignition temperatures possibly resulting in spontaneous combustion. Container may rupture from gas generation in a fire situation.

EXTINGUISHING MEDIA: Water fog or fine spray, carbon dioxide, dry chemical, foam. Alcohol resistant foams (ATC type) are preferred if available. General purpose synthetic foams (including AFFF) or protein foams may function, but much less effectively. Do not use direct water stream. May spread fire.

MEDIA TO BE AVOIDED: Do not use direct water stream.

FIRE FIGHTING INSTRUCTIONS: Keep people away. Isolate fire area and deny unnecessary entry. Burning liquids may be moved by flushing with water to protect personnel and minimize property damage. Burning liquids may be extinguished by dilution with water. Do not use direct water stream. May spread fire. Fight fire from protected location or safe distance. Consider use of unmanned hose holder or monitor nozzles. Use water spray to cool fire exposed containers and fire affected zone until fire is out and danger of re-ignition has passed. Immediately withdraw all personnel from area in case of rising sound from venting safety device or discolouration of the container. Move container from fire area if this is possible without hazard.

PROTECTIVE EQUIPMENT FOR FIRE FIGHTERS: Wear positive-pressure self-contained breathing apparatus (SCBA) and protective fire fighting clothing (includes fire fighting helmet, coat, pants, boots and gloves). If protective equipment is not available or not used, fight fire from a protected location or safe distance.

™ indicates a trademark of The Dow Chemical Company.

INSTALLATION AND OPERATION MANUAL, SELF-GENERATING STEAM JACKETED
COUNTER TILTING KETTLES, MODELS: EC-6TW-2, EC-10TW-2, EC-12TW-2

MATERIAL SAFETY DATA SHEET

Product: DOWFROST™ HD HEAT TRANSFER FLUID, DYED

Product Code: 04632

Effective Date: 08/03/04, Date Printed: 08/04/04, MSD: 002239

6. ACCIDENTAL RELEASE MEASURES (See Section 15 for Regulatory Information)

PROTECT PEOPLE: Use appropriate safety equipment. For additional information, refer to Section 8, Exposure Controls/ Personal Protection.

PROTECT THE ENVIRONMENT: Avoid contamination of all waterways.

CLEAN-UP: See Section 13, Disposal Consideration.

7. HANDLING AND STORAGE

SPECIAL PRECAUTIONS TO BE TAKEN IN HANDLING AND STORAGE: No special handling requirements data available.

HANDLING: See Section 8, Exposure Controls/Personal Protection.

STORAGE: See Section 10, Stability and Reactivity.

8. EXPOSURE CONTROLS/PERSONAL PROTECTION

ENGINEERING CONTROLS: Provide general and/or local exhaust ventilation to control airborne levels below the exposure guidelines.

PERSONAL PROTECTIVE EQUIPMENT

EYE/FACE PROTECTION: Use safety glasses. Safety glasses should be sufficient for most operations; however, for misty operations wear chemical goggles.

SKIN PROTECTION: Use gloves impervious to this material.

RESPIRATORY PROTECTION: Atmospheric levels should be maintained below the exposure guideline. When respiratory protection is required for certain operations, use an approved air-purifying respirator. In misty atmospheres, use an approved mist respirator.

™ indicates a trademark of The Dow Chemical Company.

INSTALLATION AND OPERATION MANUAL, SELF-GENERATING STEAM JACKETED
COUNTER TILTING KETTLES, MODELS: EC-6TW-2, EC-10TW-2, EC-12TW-2

MATERIAL SAFETY DATA SHEET

Product: DOWFROST™ HD HEAT TRANSFER FLUID, DYED

Product Code: 04632

Effective Date: 08/03/04, Date Printed: 08/04/04, MSD: 002239

EXPOSURE GUIDELINES: Propylene glycol: AIHA WEEL is 10 mg/m³ for total vapour and aerosol.

9. PHYSICAL AND CHEMICAL PROPERTIES

APPEARANCE/PHYSICAL STATE:	Clear yellow liquid.
ODOUR:	Odourless
VAPOUR PRESSURE:	0.22 mmHg @ 20°C
VAPOUR DENSITY:	2.6
BOILING POINT:	320°F, 160°C
SOLUBILITY IN WATER/MISCIBILITY:	Complete
SPECIFIC GRAVITY OR DENSITY:	1.058 @ 25/25°C

10. STABILITY AND REACTIVITY

CHEMICAL STABILITY: Thermally stable at typical use temperatures.

CONDITIONS TO AVOID: Avoid use temperatures above 450°F, 232°C. Product can degrade at elevated temperatures. Generation of gas during decomposition can cause pressure in closed systems.

INCOMPATIBILITY WITH OTHER MATERIALS: Avoid contact with oxidizing materials. Avoid contact with strong acids

HAZARDOUS DECOMPOSITION PRODUCTS: Hazardous decomposition products depend upon temperature, air supply and the presence of other materials.

HAZARDOUS POLYMERIZATION: Will not occur.

11. TOXICOLOGICAL INFORMATION (See Section 3 for Potential Health Effects. For detailed toxicological data, write or call the address or non-emergency number shown in Section 1).

SKIN: The LD50 for skin absorption in rabbits is >10,000 mg/kg.

™ indicates a trademark of The Dow Chemical Company.

INSTALLATION AND OPERATION MANUAL, SELF-GENERATING STEAM JACKETED
COUNTER TILTING KETTLES, MODELS: EC-6TW-2, EC-10TW-2, EC-12TW-2

MATERIAL SAFETY DATA SHEET

Product: DOWFROST™ HD HEAT TRANSFER FLUID, DYED

Product Code: 04632

Effective Date: 08/03/04, Date Printed: 08/04/04, MSD: 002239

INGESTION: The oral LD50 for rats is 20,000 - 34,000 mg/kg.

MUTAGENICITY: In vitro mutagenicity studies were negative. Animal mutagenicity studies were negative.

12. ECOLOGICAL INFORMATION (For detailed Ecological data, write or call the address or non-emergency number shown in Section 1.)

ENVIRONMENTAL FATE

MOVEMENT & PARTITIONING: Based largely or completely on data for major component(s). Bioconcentration potential is low (BCF less than 100 or Log Pow less than 3). Potential for mobility in soil is very high (Koc between 0 and 50).

DEGRADATION AND PERSISTENCE: Based largely or completely on data for major component(s). Material is readily biodegradable. Passes OECD test(s) for ready biodegradability. Degradation is expected in the atmospheric environment within minutes to hours.

ECOTOXICITY: Based largely or completely on data for major component(s). Material is practically non-toxic to aquatic organisms on an acute basis (LC50/EC50 >100 mg/L in most sensitive species).

13. DISPOSAL CONSIDERATIONS (See Section 15 for Regulatory Information)

DISPOSAL: DO NOT DUMP INTO ANY SEWERS, ON THE GROUND OR INTO ANY BODY OF WATER. All disposal methods must be in compliance with all Federal, State/Provincial and local laws and regulations. Regulations may vary in different locations. Waste characterizations and compliance with applicable laws are the responsibility solely of the waste generator. THE DOW CHEMICAL COMPANY HAS NO CONTROL OVER THE MANAGEMENT PRACTICES OR MANUFACTURING PROCESSES OF PARTIES HANDLING OR USING THIS MATERIAL. THE INFORMATION PRESENTED HERE PERTAINS ONLY TO THE PRODUCT AS SHIPPED IN ITS INTENDED CONDITION AS DESCRIBED IN MSDS SECTION 2 (Composition/Information On Ingredients).

[™] indicates a trademark of The Dow Chemical Company.

INSTALLATION AND OPERATION MANUAL, SELF-GENERATING STEAM JACKETED
COUNTER TILTING KETTLES, MODELS: EC-6TW-2, EC-10TW-2, EC-12TW-2

MATERIAL SAFETY DATA SHEET

Product: DOWFROST™ HD HEAT TRANSFER FLUID, DYED

Product Code: 04632

Effective Date: 08/03/04, Date Printed: 08/04/04, MSD: 002239

FOR UNUSED & UNCONTAMINATED PRODUCT, the preferred options include sending to a licensed, permitted: recycler, reclaimer, incinerator or other thermal destruction device.

As a service to its customers, Dow can provide names of information resources to help identify waste management companies and other facilities which recycle, reprocess or manage chemicals or plastics, and that manage used drums. Telephone Dow's Customer Information Center at 800-258-2436 or 989-832-1556 for further details.

14. TRANSPORT INFORMATION

DEPARTMENT OF TRANSPORTATION (D.O.T.): For D.O.T. regulatory information, if required, consult transportation regulations, product shipping papers, or contact your Dow representative.

CANADIAN TDG INFORMATION: For TDG regulatory information, if required, consult transportation regulations, product shipping papers, or your Dow representative.

15. REGULATORY INFORMATION (Not meant to be all-inclusive – selected regulations represented).

NOTICE: The information herein is presented in good faith and believed to be accurate as of the effective date shown above. However, no warranty, express or implied is given. Regulatory requirements are subject to change and may differ from one location to another; it is the buyer's responsibility to ensure that its activities comply with federal, state or provincial, and local laws. The following specific information is made for the purpose of complying with numerous federal, state or provincial, and local laws and regulations. See other sections for health and safety information.

™ indicates a trademark of The Dow Chemical Company.

INSTALLATION AND OPERATION MANUAL, SELF-GENERATING STEAM JACKETED
COUNTER TILTING KETTLES, MODELS: EC-6TW-2, EC-10TW-2, EC-12TW-2

MATERIAL SAFETY DATA SHEET

Product: DOWFROST™ HD HEAT TRANSFER FLUID, DYED

Product Code: 04632

Effective Date: 08/03/04, Date Printed: 08/04/04, MSD: 002239

U.S. REGULATIONS

SARA 313 INFORMATION: To the best of our knowledge, this product contains no chemical subject to SARA Title III Section 313 supplier notification requirements.

SARA HAZARD CATEGORY: This product has been reviewed according to the EPA "Hazard Categories" promulgated under Sections 311 and 312 of the Superfund Amendment and Reauthorization Act of 1986 (SARA Title III) and is considered, under applicable definitions, to meet the following categories:

Not to have met any hazard category.

TOXIC SUBSTANCES CONTROL ACT (TSCA):

All ingredients are on the TSCA inventory or are not required to be listed on the TSCA inventory.

STATE RIGHT-TO-KNOW: The following product components are cited on certain state lists as mentioned. Non-listed components may be shown in the composition section of the MSDS.

<u>CHEMICAL NAME</u>	<u>CAS NUMBER</u>	<u>LIST</u>
1, 2-Propanediol	000057-55-6	PA1

PA1= Pennsylvania Hazardous Substance (present at greater than or equal to 1.0%).

OSHA HAZARD COMMUNICATION STANDARD:

This product is not a "Hazardous Chemical" as defined by the OSHA Hazard Communication Standard, 29 CFR 1910.1200.

™ indicates a trademark of The Dow Chemical Company.

INSTALLATION AND OPERATION MANUAL, SELF-GENERATING STEAM JACKETED
COUNTER TILTING KETTLES, MODELS: EC-6TW-2, EC-10TW-2, EC-12TW-2

MATERIAL SAFETY DATA SHEET

Product: DOWFROST™ HD HEAT TRANSFER FLUID, DYED

Product Code: 04632

Effective Date: 08/03/04, Date Printed: 08/04/04, MSD: 002239

CANADIAN REGULATIONS

WHMIS INFORMATION: The Canadian Workplace Hazardous Materials Information System (WHMIS) Classification for this product is:

This product is not a "Controlled Product" under WHMIS.

CANADIAN ENVIRONMENTAL PROTECTION ACT (CEPA)

This product contains one or more substances which are not listed on the Canadian Domestic Substances List (DSL). Contact your Dow representative for more information.

16. OTHER INFORMATION

MSDS STATUS: Revised Section 8 (Exposure Guidelines).

™ indicates a trademark of The Dow Chemical Company.

The information herein is given in good faith, but no warranty, express or implied, is made. Consult The Dow Chemical Company for further information.