



Architect/Engineering Specifications:

Single hole deck mount mixing faucet with polished chrome plated brass body, retractable arm assembly, down pipe with heat resistant handle, 0.65 GPM low flow spray valve, compression cartridges with spring checks, lever handles, wall bracket, and 18" flexible stainless steel supply hoses with 1/2" NPSM / 5/8" compression connections. Certified to ASME A112.18.1/CSA B125.1, NSF 61-Section 9 and NSF 372. EPAAct 2005 compliant.

Job Name _____

Model Specified _____ Quantity _____

Variations Specified _____

Date _____

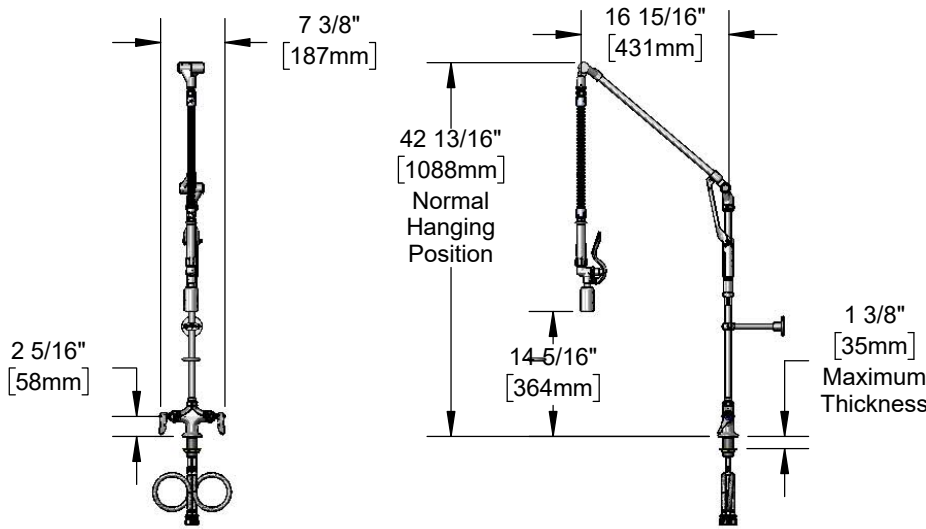

Features & Benefits:

- Single hole deck mount mixing faucet w/ polished chrome plated brass body
- Retractable arm assembly
- Down pipe w/ heat resistant gray handle and hold down ring
- 0.65 GPM low flow spray valve
- Quarter-turn Eterna compression cartridges with spring checks to prevent cross flow of water
- Lever handles w/ color coded indexes
- 18" flexible stainless steel supply hoses w/ 1/2" NPSM / 5/8" O.D. compression connections
- 6" wall bracket
- 42" high at normal hanging position
- 21 1/2" overhang at maximum pull down
- 1" clearance in maximum pull down position
- Material: Polished chrome plated brass body, retractable arm assembly, down pipe & spray valve and chrome plated metal handles

Product Compliance:

- ASME A112.18.1 / CSA B125.1
- NSF 61 - Section 9
- NSF 372 (Low Lead Content)
- EPAAct 2005 (PRSV)
- EPA WaterSense (PRSV)



Warranty: One Year (Limited)



Performance Data:

- Pressure: 20 - 125 psi
- Temperature: 40 °F - 140 °F
- Flow Rate: 0.65 GPM @ 60 psi

Optional Cartridges With Checks

- Quarter-Turn Cerama w/ Check Valve
- Quarter-Turn Eterna w/ Spring Check (Standard)

Optional Handles

- 4" Wrist Action
- Lever (Standard)
- 4-Arm

Optional Pre-Rinse Spray Valves

- B-0107 (1.42 GPM)
- B-0107-C (0.65 GPM) (Standard)
- B-0107-J (1.07 GPM)
- B-0108 (1.07 GPM)
- B-0108-C (0.65 GPM)

