

# Owner's Manual

## HIGH SPEED COMMERCIAL COMBINATION OVEN

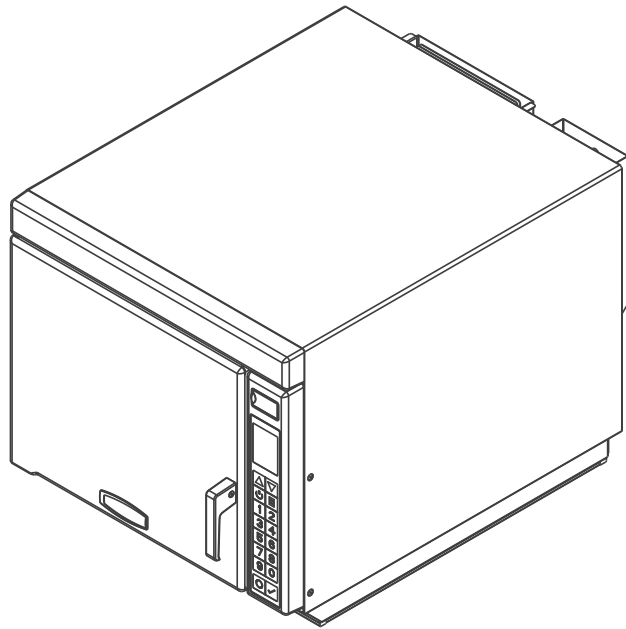

STYLE 1

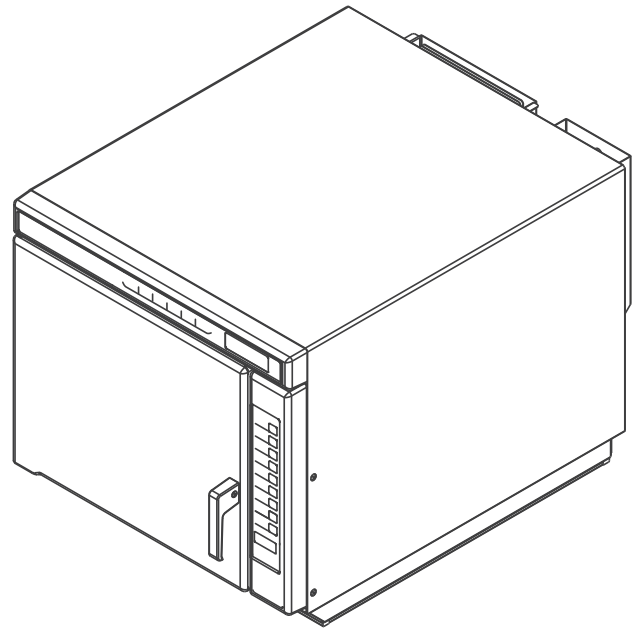

STYLE 2

### TABLE OF CONTENTS

- Model Identification.....2
- Online Oven Resources.....2
- Important Safety Instructions.....3
- Grounding & Installation.....5
- Cooking Tips.....6
- Style 1
  - Oven & Control Panel Features.....7
  - Cooking & Programming Features.....8
  - General Oven Screens.....9
  - General Oven Operation.....10
  - Manual Cook Mode.....11
  - Operating Preset Recipe Keypads.....12
  - Edit Recipe Screens.....13
  - Edit Recipe Mode.....14
  - Edit Recipe Mode: Folders.....15
  - Microwave-Only Mode.....16
  - USB Flash Drive.....17
  - User Options.....18
- Style 2
  - Oven & Control Panel Features.....19
  - Cooking & Programming Features.....20
  - Displays.....21
  - Basic Operation & Cooking.....22
  - Programming & USB Flash Drive.....23
  - User Options.....24
- Care & Cleaning.....25
- Before Calling for Service.....26



Keep these instructions for future reference. If the equipment changes ownership, be sure this manual accompanies equipment. Please refer to the SAFETY INSTRUCTIONS for important safety information prior to using this oven

# Model Identification

---

When contacting ACP, provide product information. Product information is located on oven serial plate. Record the following information:

Model Number: \_\_\_\_\_  
Manufacturing Number: \_\_\_\_\_  
Serial or S/N Number: \_\_\_\_\_  
Date of purchase: \_\_\_\_\_  
Dealer's name and address: \_\_\_\_\_  
\_\_\_\_\_  
\_\_\_\_\_

Keep a copy of sales receipt for future reference or in case warranty service is required.

Any questions or to locate an authorized ACP servicer, call ACP ComServ Service Support.

- **Inside** the U.S.A. or Canada, call toll-free at 866-426-2621.
- **Outside** the U.S.A. and Canada, call 319-368-8195.
- **Email:** [commercialservice@acpsolutions.com](mailto:commercialservice@acpsolutions.com)

Warranty service must be performed by an authorized ACP servicer. ACP also recommends contacting an authorized ACP servicer, or ACP ComServ Service Support if service is required after warranty expires.

Before using your oven, please take the time to read the Safety Instructions which shipped with the oven.

Information herein is subject to change without notice. Errors are subject to correction. For the most recent product literature, please visit [acpsolutions.com/product-literature/](http://acpsolutions.com/product-literature/)



## Online Oven Resources

### ACP PROGRAMMING APPLICATION



Download and install the ACP Programming Application to create, edit, and customize menu and display settings for your oven, using a desktop computer or tablet.

To download the latest and greatest version of the ACP Programming Application please visit [acpsolutions.com/oven-programming/](http://acpsolutions.com/oven-programming/)

# IMPORTANT SAFETY INSTRUCTIONS

## **RECOGNIZE THIS SYMBOL AS A SAFETY MESSAGE**

### **WARNING**

When using electrical equipment, basic safety precautions should be followed to reduce the risk of burns, electrical shock, fire, or injury to persons including the following.

1. READ all instructions before using equipment.
2. READ AND FOLLOW the specific "PRECAUTIONS TO AVOID POSSIBLE EXPOSURE TO EXCESSIVE MICROWAVE ENERGY" on this page.
3. This equipment **MUST BE GROUNDED**. Connect only to properly GROUNDED outlet. See "GROUNDING / EARTHING INSTRUCTIONS".
4. Install or locate this equipment **ONLY** in accordance with the installation instructions in this manual.
5. Liquids or other foods, must **NOT** be HEATED in sealed containers since they are liable to explode.
6. Eggs in their shell and whole hard-boiled eggs should **NOT** be HEATED in microwave ovens since they may explode even after microwave heating has ended.
7. Use this equipment **ONLY** for its intended use as described in this manual. **DO NOT** use corrosive chemicals or vapors in this equipment. This type of oven is specifically designed to heat, cook, or dry food. It is not designed for industrial or laboratory use.
8. This appliance is **NOT** intended for use by persons (including children) with reduced physical, sensory or mental capabilities, or lack of experience and knowledge, unless they have been given supervision or instruction concerning use of the appliance by a person responsible for their safety
9. **CHILDREN SHOULD BE SUPERVISED** to ensure that they **DO NOT** play with the appliance
10. Failure to maintain the oven in a clean condition could lead to deterioration of the surface that could adversely affect the life of the appliance and possibly result in a hazardous situation;
11. See door cleaning instructions on *page 25* of this product safety manual.
12. **DO NOT** heat baby bottles in oven. Baby food jars shall be open when heated and contents stirred or shaken before consumption, in order to avoid burns.
13. **DO NOT** operate this equipment if it has a damaged cord or plug, if it is not working properly, or if it has been damaged or dropped.
14. This equipment, including power cord, must be serviced **ONLY** by qualified service personnel. Special tools are required to service equipment. Contact nearest authorized service facility for examination, repair, or adjustment.
15. **DO NOT** cover or block louvers or other openings on equipment.
16. **DO NOT** store this equipment outdoors. **DO NOT** use this product near water – for example, near a kitchen sink, in a wet basement, a swimming pool, or a similar location.
17. **DO NOT** immerse cord or plug in water.
18. Keep cord **AWAY** from HEATED surfaces.
19. **DO NOT** let cord hang over edge of table or counter.
20. For commercial use only.

## **PRECAUTIONS TO AVOID POSSIBLE EXPOSURE TO EXCESSIVE MICROWAVE ENERGY**

- A. **DO NOT** attempt to operate this oven with the door open since open door operation can result in harmful exposure to microwave energy. It is important not to defeat or tamper with the safety interlocks.
- B. **DO NOT** place any object between the oven front face and the door too allow soil or cleaner residue to accumulate on sealing surfaces.
- C. **DO NOT** operate the oven if it is damaged. It is particularly important that the oven door close properly and that there is no damage to the:
  1. door (bent)
  2. hinges and latches (broken or loosened)
  3. door seals and sealing surfaces.
- D. The oven should not be adjusted or repaired by anyone except properly qualified service personnel.

**SAVE THESE INSTRUCTIONS**

## **WARNING**

To avoid risk of fire in the oven cavity:

- A. DO NOT overcook food. Carefully attend oven when paper, plastic, or other combustible materials are placed inside the oven, due to the possibility of ignition.
- B. Remove wire twist-ties from paper or plastic bags before placing bag in oven.
- C. If materials inside the oven ignite, keep oven door CLOSED, turn oven off and disconnect the power cord, or shut off power at the fuse or circuit breaker panel.
- D. DO NOT use the cavity for storage. DO NOT leave paper products, cooking utensils, or food in the cavity when not in use.

## **WARNING**

Liquids such as water, coffee, or tea are able to be overheated beyond the boiling point without appearing to be boiling due to surface tension of the liquid. Visible bubbling or boiling when the container is removed from the microwave oven is not always present. **THIS COULD RESULT IN VERY HOT LIQUIDS SUDDENLY BOILING OVER WHEN A SPOON OR OTHER UTENSIL IS INSERTED INTO THE LIQUID.** To reduce the risk of injury to persons:

- i. DO NOT overheat the liquid.
- ii. Stir the liquid both before and halfway through heating it.
- iii. DO NOT use straight-sided containers with narrow necks.
- iv. After heating, allow the container to stand in the microwave oven for a short time before removing the container.
- v. Use extreme care when inserting a spoon or other utensil into the container.

## **CAUTION**

To avoid personal injury or property damage, observe the following:

- 1. DO NOT deep fat fry in oven. Fat could overheat and be hazardous to handle.
- 2. DO NOT cook or reheat eggs in shell or with an unbroken yolk using microwave energy. Pressure may build up and erupt. Pierce yolk with fork or knife before cooking.
- 3. Pierce skin of potatoes, tomatoes, and similar foods before cooking with microwave energy. When skin is pierced, steam escapes evenly.
- 4. DO NOT operate equipment without load or food in oven cavity.
- 5. Microwave popcorn should not be popped in oven.
- 6. DO NOT use regular cooking thermometers in oven. Most cooking thermometers contain mercury and may cause an electrical arc, malfunction, or damage to oven.
- 7. DO NOT use metal utensils in oven.
- 8. DO NOT use aluminum foil in oven
- 9. Never use paper, plastic, or other combustible materials that are not intended for cooking.
- 10. When cooking with paper, plastic, or other combustible materials, follow manufacturer's recommendations on product use.
- 11. DO NOT use paper towels which contain nylon or other synthetic fibers. Heated synthetics could melt and cause paper to ignite.
- 12. DO NOT heat sealed containers or plastic bags in oven. Food or liquid could expand quickly and cause container or bag to break. Pierce or open container or bag before heating.
- 13. To avoid pacemaker malfunction, consult physician or pacemaker manufacturer about effects of microwave energy on pacemaker.
- 14. An authorized servicer MUST inspect equipment annually. Record all inspections and repairs for future use.

**SAVE THESE INSTRUCTIONS**

# Grounding & Installation

## Grounding/Earthing Instructions



**Oven MUST be grounded.** Grounding reduces risk of electric shock by providing an escape wire for the electric current if an electrical short occurs. This oven is equipped with a cord having a grounding wire with a grounding plug. The plug must be plugged into an outlet that is properly installed and grounded.

**WARNING**

To avoid risk of electrical shock or death, this oven must be grounded and plug must not be altered.

Consult a qualified electrician or servicer if grounding instructions are not completely understood, or if doubt exists as to whether the oven is properly grounded.

### Do not use an extension cord.

If the product power cord is too short, have a qualified electrician install a three-slot receptacle. This oven should be plugged into a separate circuit with the electrical rating as provided in product specifications (available at [www.acpsolutions.com](http://www.acpsolutions.com)) and the oven's serial plate / rating label. When the oven is on a circuit with other equipment, an increase in cooking times may be required and fuses can be blown.

## EXTERNAL EQUIPOTENTIAL EARTHING TERMINAL (export only)

Equipment has secondary earthing terminal. Terminal provides external earthing connection used in addition to earthing prong on plug. Located on outside of oven back, terminal is marked with symbol shown at right



# Installation

## Unpacking Oven

- Inspect oven for damage such as dents in door or inside oven cavity.
- Report any dents or breakage to source of purchase immediately.  
**Do not attempt to use oven if damaged.**
- Remove all packing materials from oven interior.
- If oven has been stored in extremely cold area, wait a few hours before connecting power.

**WARNING**

**Excessive Weight Hazard**

Use two or more people to move and install oven. Failure to do so can result in back or other injury

## Radio Interference

- Microwave operation may cause interference to radio, television. Reduce or eliminate interference by doing the following:
- Clean door and sealing surfaces of oven according to instructions in "Care & Cleaning" section.

## Oven Placement

- Do not install oven next to or above source of heat, such as pizza oven or deep fat fryer. This could cause oven to operate improperly and could shorten life of electrical parts.
- Do not block or obstruct oven filters. Allow access for cleaning.
- Install oven on level counter-top surface.
- If provided, place warning label in a conspicuous place close to oven.
- Outlet should be located so that plug is accessible when oven is in place.

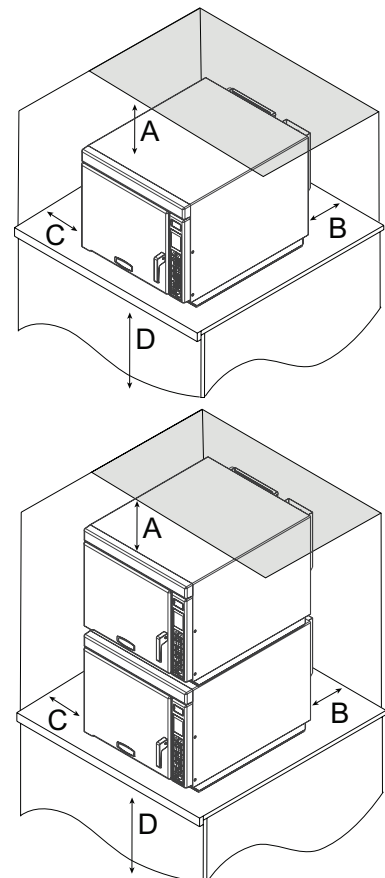

### OVEN CLEARANCES

- Allow at least 4" (10 cm) of clearance around top of oven. Proper air flow around oven cools electrical components. With restricted air flow, oven may not operate properly and life of electrical parts is reduced.
- There is not an installation clearance requirement for the back of the oven.
- Allow at least 1" (2.54 cm) of clearance around sides of oven.
- Install oven so oven bottom is at least 3 feet (91.5 cm) above floor.

# Cooking Tips

## Oven Temperature

- Oven can be preheated to the following temperature range:
  - STYLE 1 Models:** 200°– 475°F (95°– 250°C)
  - STYLE 2 Models:** 150°– 475°F (65°– 250°C)
- The most frequently used oven temperature is 475°F (250°C).
- Use only one temperature for all your menu items to avoid cooking inconsistency.
- Reduced oven temperature may be needed for baking or if product is cooked for an extended period of time.

## Microwave Settings

- 11 different power levels (0% lowest to 100% highest) control intensity of microwave energy.
- Microwave energy cooks the food and increases the internal food temperature.
- Food containing high water, fat and salt content raises its temperature faster with high microwave power level.
- Decreasing microwave power is recommended when product is thick and takes longer to cook to avoid drying out food.

## Stage Cooking

Allows operator to use up to four different cooking cycles or stages consecutively without repeated input from the operator. Stage cooking aids in retaining the quality of frozen and delicate foods. It can be set to defrost food initially, then cook it, and then finish with more toasting/browning.

*Note: Combined total cook time cannot exceed 20:00*

### Example: Pizza

Total Cook Time: 3:45		
Temperature: 475°F (250°C)		
STAGE	TIME	% MW POWER
1	1:00	80%
2	1:30	30%
3	1:15	50%
4	-	-

Stage one thaws and begins cooking process. Stage two continues cooking process without drying out pizza crust. Stage three increases the internal temperature of the pizza.

## Best Practices

- Remove food from oven at end of cycle. Items will be hot when finished cooking. Use oven mitt, tongs, or pizza paddle to safely remove items from oven.
- Place cookware in center of oven rack, not touching oven sides.
- Clean oven daily. See "Care & Cleaning" on page 25 of this manual for full instructions.
- For easier cleaning, use non-stick liner kit accessory and replace whenever you encounter excessive peeling or wear. (Item# TL12)
- Style 1 Models:** Use magnetic air filter accessory to enhance filtering of fine particulates that may be in the air with select installations/applications. (Item# AF10)

## Cooking Utensils and Containers

ONLY use accessories that are both high temperature oven-safe and microwave-safe.

### FOR CONVECTION AND/OR COMBINATION COOKING:

- Maximum metal pan height: 1½ inches (38mm). Assure pans do not contact oven or door surfaces during cooking.
- Different types of metal conduct heat at different speeds. Aluminum heats faster than stainless steel.
- Line pans with parchment paper for easy removal of food after heating and cleaning.

RECOMMENDED	NOT RECOMMENDED
Parchment Paper	Aluminum and/or metal foil
Non-Stick Baskets (TB10/S, SB10/S, MB10S)	Grocery bags
Pizza Stone (ST10C)	Recycled paper
Panini Grill Accessory (JR10)	Lead crystal
Drip Tray/Griddle (DR10)	Newspapers
1/4-size Aluminum Sheet Pan (height ≤ 1½ in. (38mm))	Metallic trimmed china
12in (30cm) Pizza Screen	Plastic wrap
Ceramic Dish	
High-temperature glass	

### FOR MICROWAVE-ONLY COOKING:

- Do NOT use cooking containers or covers with metal content. This includes all metal and enameled metal-core ware, foil, and metal-trimmed containers.

RECOMMENDED	NOT RECOMMENDED
Glass/Ceramic	Aluminum and/or metal foil
Parchment Paper	Grocery bags
Non-Stick Baskets (TB10/S, SB10/S, MB10S)	Recycled paper
	Lead crystal
	Newspapers
	Metal
	Metallic trimmed china
	Plastic wrap

## Available Oven Accessories

- Non-Stick Baskets** (Item#: TB10/S, SB10/S, MB10S): Aids in browning and crisping of food. Makes cleanup easier.
- Pizza Stone** (Item#: ST10C): Aids in crisping and browning breads and pizzas. Preheat pizza stone for 30-35 minutes to heat thoroughly.
- Panini Grill Accessory** (Item#: JR10): Aids in adding grill marks on a product. Preheat grill plate for 15 minutes to heat thoroughly.
- Drip Tray/Griddle** (Item#: DR10): Makes cleanup easier. Aids in crisping and browning. Preheat griddle for 15 minutes to heat thoroughly.
- Oven Paddle** (Item#: PA10): Aids in safe removal of food from the oven.
- Non-Stick Liner Kit** (Item#: TL12): Makes cleanup easier and protects oven interior.
- Oven Floor Liner** (Item#: OV10): Makes cleanup easier.
- Oven Rack** (Item#: RA14): Replacement stainless steel interior oven rack
- Magnetic Air Filter** (Item#: AF10): Removable/cleanable magnetic air filter. Enhances filtering of fine particulates that may be in the air with select installations/applications (for STYLE 1 Models)
- ACP Oven Cleaner** (Item#: CL10 (US), CL10W (EU))
- ACP Oven Shield Protectant** (Item#: SH10 (US), PR10W (EU))

*Note: There are multiple styles of controls. Choose the control that matches unit. Control panel coloring may vary by model*

## Oven Features

- (1) **USB PORT / PROTECTIVE COVER**
- (2) **DISPLAY**
- (3) **CONTROL PANEL**
- (4) **DOOR HANDLE**  
Ergonomically designed for one handed "Lift and Pull" operation.
- (5) **AIR INTAKE FILTER (not pictured)**  
Non-removable air intake filter.
  - (i) **Optional Accessory: Magnetic Air Filter (Item# AF10)**  
Removable/cleanable magnetic air filter. Enhances filtering of fine particulates that may be in the air with select installations/applications
- (6) **OVEN RACK (not pictured)**  
The oven is equipped with a removable stainless steel oven rack. 2 available installation positions.
- (7) **UNIT SERIAL NUMBER (not pictured)**  
Located inside the door and on the back of the oven.

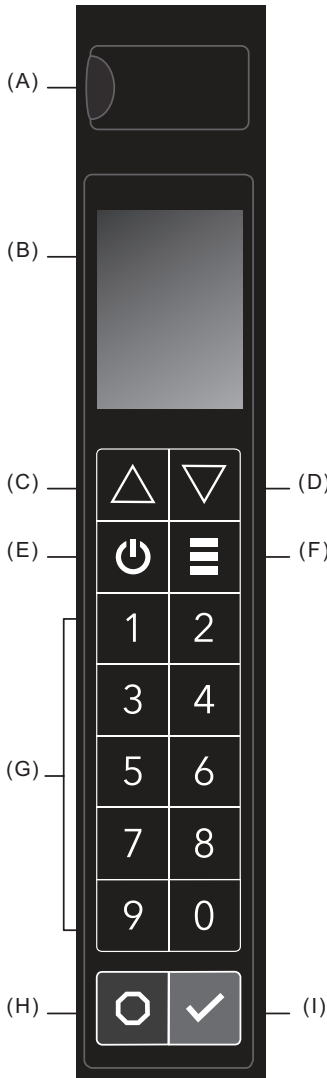
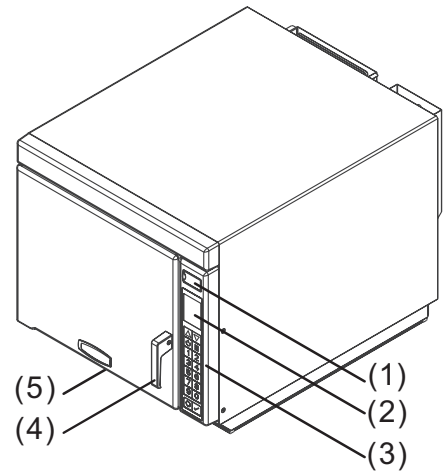

## Control Panel Features

- (A) **USB PORT**  
Standard USB flash drive compatible. Allows for import/export of recipes and user options, and to update firmware.
- (B) **DISPLAY**  
2.8" (71 mm) Color LCD Display
- (C) **UP KEYPAD**  
Scrolls up through editable fields and pages.
- (D) **DOWN KEYPAD**  
Scrolls down through editable fields and pages.
- (E) **POWER ON/OFF KEYPAD**  
Preheats oven. Begins cool-down process.
- (F) **MENU KEYPAD**  
Opens Main Menu screen to access features including: adjust preheat temperature; edit recipes; manual cook mode; adjust date/time settings; change user options; load menu files; enter service mode; and/or activate microwave-only cooking.
- (G) **NUMBER KEYPADS**  
Used to operate preset recipes; enter settings; and navigate through display.
- (H) **STOP/RESET KEYPAD**  
Interrupts operation, and/or exits modes and menus.
- (I) **START/OK KEYPAD**  
Begins cooking in Manual Time Entry Mode. Restarts an interrupted cooking cycle. Used to save settings and entries.



## Cooking Energies and Options

<p align="center"><b>CONVECTION ENERGY</b></p> <p>Convection cooking utilizes both a convection element and fan to evenly distribute heated air throughout the oven cavity. The circulating air surrounds food in an envelope of evenly heated air. Consistent temperatures cook food evenly and reduce cooking time. By default, convection power is enabled. While enabled, oven will maintain a minimum convection temperature of 200°F (95°C) to ensure drier air and more even cooking.</p>		<p align="center"><b>MICROWAVE ENERGY</b></p> <p>Microwave cooking uses high frequency energy waves to heat the food. When cooking, microwave energy causes food molecules to move rapidly. This rapid movement between the food molecules creates heat, which cooks the food. Oven generates microwave energy while cooking screen countdowns and displays power level greater than 0%.</p>
<p align="center"><b>Convection-Only Cooking</b></p> <p>To operate with convection-only, use cook settings with 0% microwave power level.</p>	<p align="center"><b>Combination Cooking: Convection with Microwave</b></p> <p>The combination of both energies uses the speed of microwave energy and browning of convection cooking to yield high quality food faster. To operate with combination cooking, set convection temperature between 200°– 475°F (95°– 250°C), and set microwave power level between 10 – 100%.</p>	<p align="center"><b>Microwave-Only Cooking</b></p> <p>Microwave-Only mode allows operator to disable convection power and cook using only microwave energy. To operate with microwave-only, see <i>page 16</i>.</p>

## Programming Features

### STAGE COOKING

Allows operator to use up to four different cooking cycles or stages consecutively without repeated input from the operator. For example, stage cooking can be set to defrost food initially, then cook it, and then finish with more toasting/browning.

### PRESET RECIPE KEYPADS

Oven can store between 10 to 100 recipes in memory.  
Available quantity varies based on “Digit Entry” User Option.  
*Note: To change Digit Entry options, see “User Options” section in this manual.*

DIGIT ENTRY USER OPTION	AVAILABLE RECIPES
<b>1</b> <i>Single Digit</i>	10 recipes (0-9) <b>(10 total recipes)</b>
<b>01</b> <i>Double Digit</i>	100 recipes (00-99) <b>(100 total recipes)</b>
<b>1</b> <i>Folders</i>	10 folders (0-9) ↳ 10 recipes per folder (0-9) <b>(100 total recipes)</b>

### QUANTITY PROMPT (SELECT MODELS)

*Note: Only available when factory option ALLOW QUANTITY PROMPT is enabled and Quantity Prompt is enabled in User Options*  
Allows operator to select preset recipe keypad(s) for a menu item, followed by the quantity of items to be heated. Cook times and settings can be customized for each recipe in quantities 1-9.

## Methods of Cooking & Programming

### COOKING WITH PRESET RECIPE KEYPADS

Allows operator to quickly activate saved cooking sequences using 1-2 keypad strokes

### MANUAL COOKING

Allows operator to heat without changing the preset recipe keypads

### MANUALLY EDIT/CREATE NEW PRESET RECIPES

Allows operator to use keypads to edit preset recipes and/or create new recipes for customized cooking.

### USB MENU IMPORT AND EXPORT

Allows operator to import and export recipe settings and user options using a standard USB flash drive

### ACP PROGRAMMING APPLICATION

Allows operator to create and edit recipe settings and user options on a computer.  
For detailed instructions, please visit: [www.acpsolutions.com/oven-programming](http://www.acpsolutions.com/oven-programming)





**STANDBY**



**WARMING UP**

Indicates oven is preheating. Target preheat temperature is displayed above the current rising temperature.

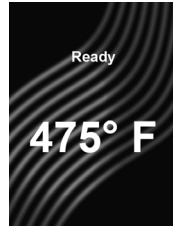

**READY**

Indicates oven is ready to operate. The operator may press keypads to begin preset recipes or MENU keypad for more options.

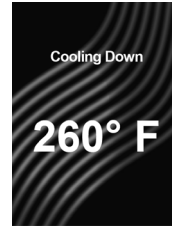

**COOLING DOWN**

Indicates oven is cooling down. Will display until oven reaches internal temperature of 200°F (95°C).



**DOOR OPEN**

## Menu

Press MENU (≡) keypad to access list of menu features and functions. To scroll between pages: Press UP/DOWN (▲▼) keypads. To access features, press corresponding number keypad.

**Note:** If PIN Code is enabled, your unique 4 digit pin code will be required to access MENU screen

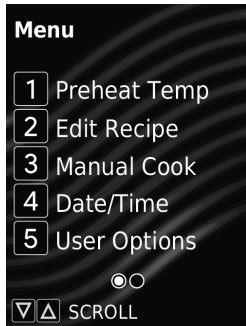

**MENU - PAGE 1 OF 2**

### "Menu" Page 1

- (1) **PREHEAT TEMPERATURE**  
Allows the operator to change the preheat temperature between 200°– 475°F (95°– 250°C).
- (2) **EDIT RECIPE**  
Allows the operator to edit or create new preset recipes/folders for customized cooking.
- (3) **MANUAL COOK**  
Allows the operator to heat without changing the preset recipe keypads.
- (4) **DATE/TIME**  
Allows the operator to set Date and Time settings for their local time.
- (5) **USER OPTIONS**  
Allows the operator to customize various oven settings.

### "Menu" Page 2

- (1) **LOAD FILE**  
Allows the operator to upload recipe settings and user options using a standard USB flash drive.
- (2) **SERVICE MENU**  
Allows authorized service technicians to access usage data, troubleshoot, and update firmware.  
**Note:** Service PIN code required for access.
- (3) **ENTER MW ONLY**  
Allows operator to disable convection power and cook using only microwave energy.

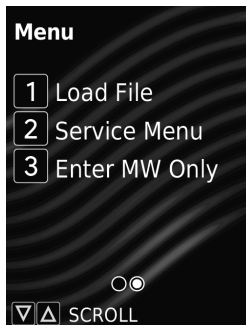

**MENU - PAGE 2 OF 2**

## Clean Filter Reminder (optional)

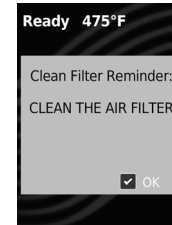

Air filters and vents must be cleaned regularly to prevent overheating of oven. When enabled, clean filter reminder message will display once the designated time period has lapsed.

Complete steps to "Clean Air Filter" on page 25. Cleaning the air filters will not shut off message. Message will automatically stop displaying after 24 hours. To clear the message, Press START/OK keypad.  
**Note:** To adjust frequency of Clean Air Filter Reminder, see "User Options" section in this manual.

## Preheat Warning (optional)

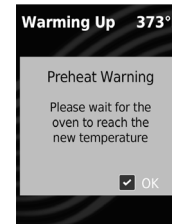

If "Preheat Warning" is enabled, and oven temperature differs from default preheat temperature, the control will interrupt cook cycle and display warning message, "Please wait for the oven to reach the new temperature."

To exit warning, press START/OK keypad. Once oven has preheated to desired temperature, you may begin cook cycle.

**Note:** To enable/disable Preheat Warning, see "User Options" section in this manual.

## STYLE 1 General Oven Operation

### Power-ON Oven, Preheat

Press POWER ON/OFF (⏻) keypad to begin preheating. WARMING UP screen will display. READY screen will display once oven reaches the specified preheat temperature.

### Power-OFF Oven, Cool-Down

Press POWER ON/OFF (⏻) keypad to begin cooling down the oven. COOLING DOWN screen will display and oven fan will continue to run. STANDBY screen will display once temperature is below 200°F (95°C).

## 1 Edit Oven Preheat Temperature

This oven can be set to a preheat temperature between 200°– 475°F (95°– 250°C). It is recommended to set to the most commonly used temperature for the oven. Factory default setting is 475°F (250°C).

1. Press MENU (≡) keypad.
  - If prompted, enter PIN Code and press START/OK keypad.
  - MENU screen will display.
2. Press number "1" keypad to access "Preheat Temp".
  - PREHEAT TEMP screen will display.
3. Press number keypads to enter desired temperature.
4. **To save changes:** Press START/OK keypad.
5. **To discard changes:** Press STOP/RESET keypad.

## 4 Set Date and Time

This oven maintains a data log which is used to diagnose and troubleshoot errors. An accurate date and time are important for the data log. To set date and time:

1. Press MENU (≡) keypad.
  - If prompted, enter PIN Code and press START/OK keypad.
  - MENU screen will display.
2. Press number "4" keypad to access "Date/Time".
  - DATE AND TIME screen will display.
3. **To edit date and time fields:** Press corresponding number keypad.
  - Active editable field is highlighted in red.
  - Editable fields include:
    - (1) Day
    - (2) Month
    - (3) Year
    - (4) Hours
    - (5) Minutes
    - (6) AM/PM/24
4. Press UP/DOWN (▲ ▼) keypads to scroll to correct setting per field.
5. **To save and exit:** Press START/OK keypad.
6. **To discard changes:** Press STOP/RESET keypad.



WARMING UP

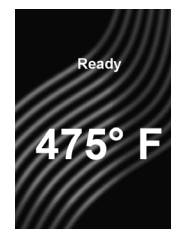

READY



COOLING DOWN



STANDBY

### Interrupt Operation

Press STOP/RESET keypad to interrupt operation. Display continues to show countdown time. Close door and press START/OK keypad to resume oven operation.

### Cancel Mistakes

*If oven is not cooking,* press STOP/RESET keypad to clear display.  
*If oven is cooking,* press STOP/RESET keypad twice to stop and clear display.

## Manual Cook Screens

### MANUAL COOK ENTRY

Displays while operator is entering cook settings in Manual Cook mode.

Active editable field is highlighted in red.

To navigate to editable fields: Press UP/DOWN (▲▼) keypads.

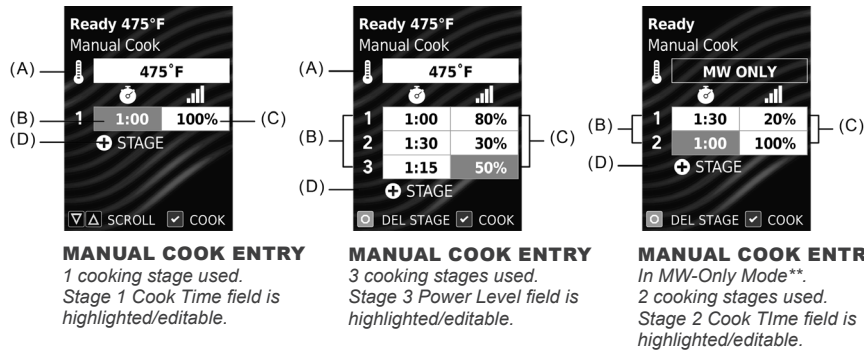

### "Manual Cook" Editable Fields:

- (A) **OVEN TEMPERATURE\*\***  
Between 200°– 475°F (95°– 250°C). Defaults to oven preheat temperature.
- (B) **COOK TIME (PER STAGE)**  
Combined total cook time cannot exceed 20:00.
- (C) **%MW POWER LEVEL (PER STAGE)**  
Percent microwave power from 0-100% in 10% increments (keypad "0" = 0%, keypad "1"=10%, keypad "2"=20%, etc.)  
For 100% power level, press any number keypad twice.
- (D) **ADD A STAGE**  
Up to four stages can be entered.

## 3 Manual Cooking

Allows operator to heat without changing the preset recipe keypads.

**Note:** Oven must be preheated before combination or convection cooking.

From READY or DOOR OPEN screen:

1. Open oven door, place food in oven, and close door.
  - READY screen will display.
2. Press MENU (≡) keypad.
  - If prompted, enter PIN Code and press START/OK keypad.
  - MENU screen will display.
3. Press number "3" keypad to access "Manual Cook".
  - MANUAL COOK ENTRY screen will display.
4. **To navigate to editable fields:** Press UP/DOWN (▲▼) keypads.
  - Active editable field is highlighted in red.
  - Editable fields include:
    - Oven Temperature\*\*
    - Cook Time (per stage)
    - %MW Power Level (per stage)
    - Add a Stage
5. Press number keypads to enter desired settings per field.
6. **To add additional cooking stages:** Press DOWN (▼) keypad until "+ STAGE" is highlighted.
  - A new row of Cook Time and %MW Power Level fields will display
  - Repeat steps 4–6 for each additional stage.
7. Press START/OK keypad to begin cooking.
  - Oven operates and display counts down cooking time.
8. At the end of the cooking cycle, the oven beeps. Oven interior and cooking dish will be hot. Carefully remove food from oven.

\*\* If Microwave-Only Mode is enabled, then Oven Temperature will read "MW ONLY" and will not be an editable field. See page 16 for details.

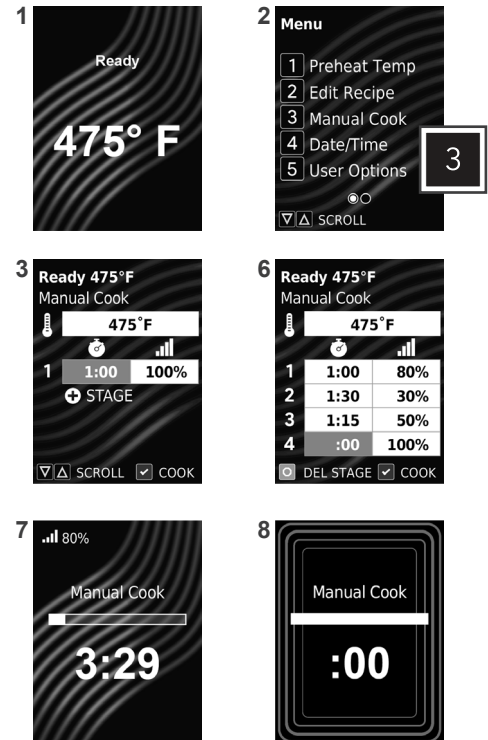

## Operating Preset Recipe Keypads

This oven can store up to 10 or 100 recipes in memory. To heat using a preset recipe, press number keypad(s). Oven will start to heat automatically.

**Note:** Oven must be preheated before combination or convection cooking.

From READY or DOOR OPEN screen:

1. Open oven door, place food in oven, and close oven door.
    - READY screen is displayed.
  2. Press desired number keypad(s):
    - **Single Digit Keypad Cooking:** Press a single keypad (0-9).
    - **Double Digit Keypad Cooking:** Press two keypads, in order, of the double digit number for the desired recipe (00-99).
    - **Folders:** Press one keypad to open folder (0-9), followed by keypad for desired recipe (0-9).
- Note:** To change Digit Entry option see "User Options" section in this manual
3. Oven operates and time counts down.
    - Display shows recipe name, and counts down cooking time.
    - If additional cooking time is required, press preset keypad(s) before or after cooking cycle ends.
  4. At the end of the cooking cycle, the oven beeps. Oven interior and cooking dish will be hot. Carefully remove food from oven.

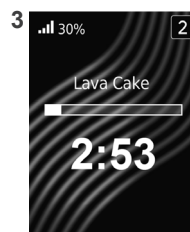
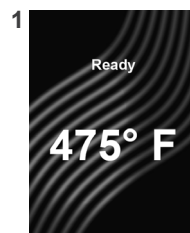

## Operating Preset Recipe Keypads with Quantity Prompt (select models)

Allows operator to select preset recipe keypad(s) for a menu item, followed by the quantity of items to be heated (1-9).

1. Press desired number keypad(s).
  - ENTER QUANTITY screen is displayed.
2. Enter desired quantity using keypad 1-9.
  - Display shows the recipe name and counts down cooking time.
  - Quantity is displayed before the recipe name. (X1, X2, X3, etc.)

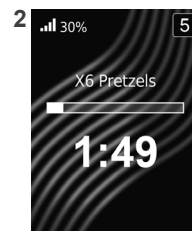
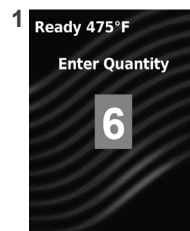

## Edit Recipe List Screens

Indicates oven is entering "Edit Recipe" mode. The operator may press keypads to open recipe and/or folder locations.

**Note:** Screens may vary based on Digit Entry option in "User Options"

(A) **RECIPE/FOLDER LOCATIONS**

Numbers represent programmed recipes and available memory locations. Unused locations are labeled "- Available." Operator may press keypad(s) to view and edit locations.

(B) **MULTIPLE PAGES**

Radio button icons indicate page number. Operator may press UP/DOWN (▲▼) keypads to scroll between pages.

(C) **PARENT FOLDER LOCATION**

If folder location is opened, the contents of the selected folder are displayed. Parent folder location is displayed above the first recipe on each page.

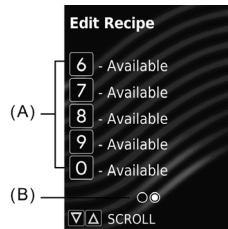

**EDIT RECIPE LIST**

Single Digit Entry.  
Page 2 of 2 shown.

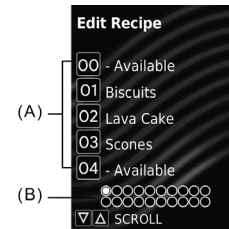

**EDIT RECIPE LIST**

Double Digit Entry.  
Page 1 of 20 shown.

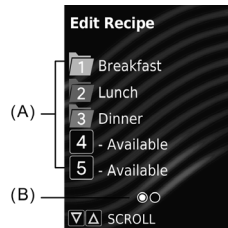

**EDIT RECIPE LIST**

Folders Digit Entry.  
Top level.  
Page 1 of 2 shown.

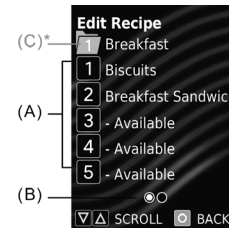

**EDIT RECIPE LIST**

Folders Digit Entry.  
Folder 1 is open.  
Folder 1 contents shown.  
Page 1 of 2 shown.

## Edit Recipe Entry Screens

Displays while a recipe or folder location is open. Stored location is represented by number at top right corner of screen. Active editable field is highlighted in red. To navigate to editable fields, press UP/DOWN (▲▼) keypads.

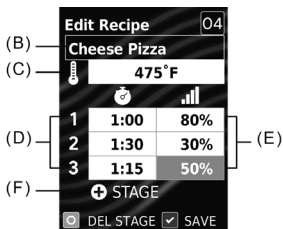

**EDIT RECIPE ENTRY**  
Double Digit Entry.  
Recipe Location "04" shown.  
Stage 3 Power Level field is highlighted/editable.

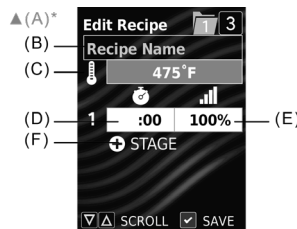

**EDIT RECIPE ENTRY**  
Folders Digit Entry.  
Recipe Location "3" within Folder "1" shown.  
Oven Temperature field is highlighted/editable.

**"Edit Recipe Entry" Editable Fields:**

- (A) **MAKE FOLDER/ FOLDER NAME\***  
See "Edit Recipe Mode: Folders" on page 15 for details.
- (B) **RECIPE NAME**  
See "Edit Name Screens" section.
- (C) **OVEN TEMPERATURE**  
Between 200°– 475°F (95°– 250°C). Defaults to oven preheat temperature.
- (D) **COOK TIME (PER STAGE)**  
Combined total cook time cannot exceed 20:00.
- (E) **%MW POWER LEVEL (PER STAGE)**  
Percent microwave power from 0-100% in 10% increments (keypad "0" = 0%, keypad "1"=10%, keypad "2"=20%,etc.) For 100% power level, press any number keypad twice.
- (F) **ADD A STAGE**  
Up to four stages can be entered.

## Edit Name Screens

Displays while editing name of recipe or folder\*. Operator may press number keypads to enter a name. To cycle through available characters: Press same keypad within 1 second.

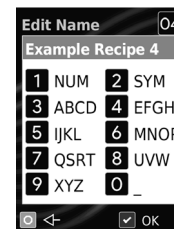

**EDIT RECIPE NAME**  
Double Digit Entry.  
Location "04" shown.

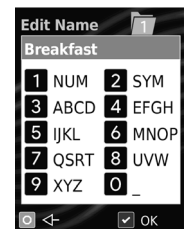

**EDIT FOLDER NAME\***  
Folders Digit Entry.  
Location "1" shown.

**"Edit Name" Keypad Functions**

KEYPAD	DESCRIPTION	TEXT FUNCTION
1	NUM	1234567890
2	SYM	.,&!?'()/~@#%^^*.-+
3	ABCD	ABCDabcd
4	EFGH	EFGHefgh
5	IJKL	IJKLijkl
6	MNOP	MNOPmnop
7	QRST	QRSTqrst
8	UVW	UVWuvw
9	XYZ	XYZxyz
0	_	(space)
START	OK	(save and exit)
STOP	<-	(backspace)

\* Make Folder and Folder Name are only available when User Options>Digit Entry>Folders is enabled and location is in top level (0-9) of Edit Recipe List. See page 15 for details.



## 2 Edit or Create New Recipes

Allows the operator to edit or create new preset recipes/folders for customized cooking. This oven can be programmed to store up to 10 or 100 preset recipes in memory.

1. Press MENU (≡) keypad.
  - If prompted, enter PIN Code and press START/OK keypad.
  - MENU screen will display.
2. Press number "2" keypad to access "Edit Recipe".
  - EDIT RECIPE LIST screen is displayed with list of preset recipes, folders, and/or available locations.
  - To scroll between pages of recipes: Press UP/DOWN (▲▼) keypads.
3. Press number keypad(s) to open the desired recipe/folder location.
  - EDIT RECIPE ENTRY screen will display.
4. **To navigate to editable fields:** Press UP/DOWN (▲▼) keypads.
  - Active editable field is highlighted in red.
  - Editable fields include:
    - *Make Folder and Folder Name\**
    - Recipe Name
    - *Oven Temperature\*\**
    - Cook Time (per stage)
    - %MW Power Level (per stage)
    - Add a Stage
5. Press number keypads to enter desired settings per field.
6. **To add additional cooking stages:** Press DOWN (▼) keypad until "+ STAGE" is highlighted.
  - A new row of Cook Time and %MW Power Level fields will display.
  - Repeat steps 4–6 for each additional stage.
7. **To save and exit:** Press START/OK keypad.
8. **To discard changes:** Press STOP/RESET keypad.

\* *Make Folder and Folder Name are only available when User Options>Digit Entry>Folders is enabled and location is in top level (0-9) of Edit Recipe List. See page 15 for details.*

\*\* *If Microwave-Only Mode is enabled, then Oven Temperature will read "MW ONLY" and will not be an editable field. See "Microwave-Only Mode" section on page 16 for details.*

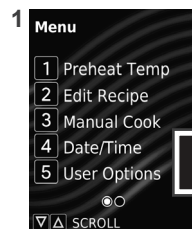

Default

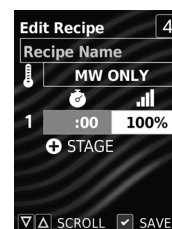

In MW-Only Mode\*\*

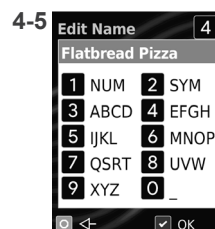

Edit Recipe Name

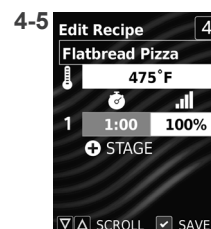

Stage 1, Cook Time

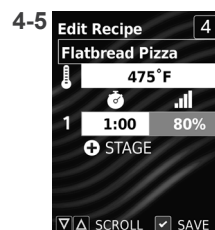

Stage 1, %MW Power

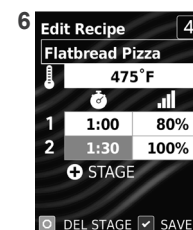

Stage 2, Cook Time

## Edit or Create New Recipes with Quantity Prompt (select models)

Cook times and settings can be customized for each recipe in quantities 1-9.

To edit the settings of a specific recipe/quantity:

1. Complete steps 1–3 in "Edit or Create New Recipes".
  - ENTER QUANTITY screen is displayed.
2. Enter desired quantity using keypad 1-9.
  - EDIT RECIPE ENTRY screen will display.
  - Quantity is displayed before the recipe name. (X1, X2, X3, etc.)
3. Complete steps 4–7 in "Edit or Create New Recipes".

Allows operator to organize recipes in folders. Folders can only be located in the top level (0-9) of EDIT RECIPE LIST. Folders cannot be created within folders.

**Note:** Folders must first be enabled in User Options>Digit Entry>Folders.

## Navigate Existing Folders

From EDIT RECIPE LIST screen:

- **To open folder:** Press number keypad to open the desired folder.
- **To exit folder:** Press STOP/RESET keypad.

## Create New Folders

1. Press MENU (≡) keypad.
2. Press number "2" keypad to access "Edit Recipe".
  - EDIT RECIPE LIST screen will display.
  - To scroll between pages of recipes: Press UP/DOWN (▲▼) keypads.
3. Press a number keypad to open the desired recipe/folder location.
  - EDIT RECIPE ENTRY screen will display.
4. Press UP (▲) keypad to navigate to Recipe Name field.
  - EDIT RECIPE NAME screen will display.
5. **To make folder:** Press UP(▲) keypad to access MAKE FOLDER screen.
  - MAKE FOLDER screen will display.
  - Press START/OK keypad to make folder.
  - EDIT FOLDER NAME screen will display.
6. **To enter folder name:** Press number keypads to enter folder name.
7. **To save folder:** Press START/OK keypad.
  - Folder will now be visible on EDIT RECIPE LIST screen.

## Edit or Create New Recipes Within Folders

1. Complete steps 1–2 in "Create New Folders" section above.
2. Press a number keypad to open the desired folder location.
  - EDIT RECIPE LIST screen is displayed with contents of the selected folder. Parent folder location is displayed above the first recipe on each page.
  - To scroll between pages of recipes: Press UP/DOWN (▲▼) keypads.
3. Press a number keypad to open the desired recipe location within the folder.
  - EDIT RECIPE ENTRY screen is displayed, with parent folder location displayed to the left of the current recipe location.
4. To create recipe: Complete steps 4–7 in "Edit or Create New Recipes" on page 14.

## Edit Folder Name

From EDIT RECIPE LIST screen:

1. Press and hold number keypad of corresponding folder.
  - EDIT FOLDER NAME screen will display.
2. Press number keypads to edit folder name.
3. To save changes and exit folder: Press START/OK keypad.

## Delete Folder

**Caution:** Deleting a folder will make its contents inaccessible.

From EDIT RECIPE LIST screen:

1. Press and hold number keypad to corresponding folder.
  - EDIT FOLDER NAME screen will display.
2. Press UP (▲) keypad.
  - DELETE FOLDER screen is displayed.
3. To delete folder: Press START/OK keypad.
4. Press START/OK keypad again to exit EDIT RECIPE NAME screen.
5. To save changes and exit: Press START/OK keypad.

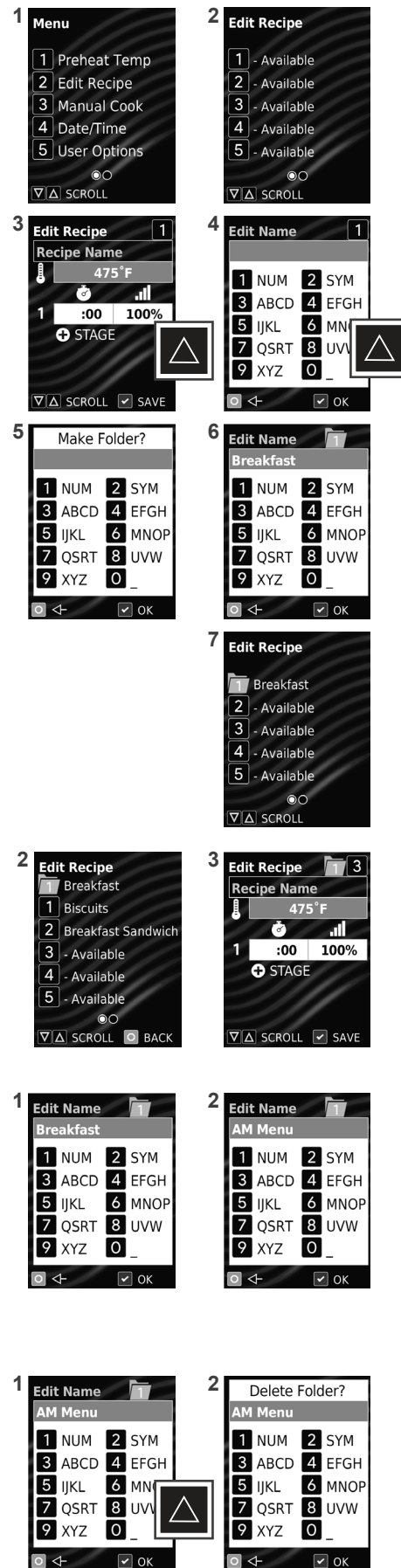



## STYLE 1 Microwave-Only Mode

Microwave-Only Mode (MW-Only Mode) allows operator to disable convection power and cook using only microwave energy.

### 3 Enter MW-Only Mode

Oven must cool-down before microwave-only mode can be enabled.

1. If oven is preheated, Press POWER ON/OFF (⏻) keypad to begin cooling-down the oven.
  - COOLING DOWN screen will display until oven temperature is below 200°F (95°C).
  - Once cooled, STANDBY screen will display.
2. Press MENU (☰) keypad.
  - If prompted, enter PIN Code and press START/OK keypad.
  - MENU screen will display.
3. Press DOWN (▼) keypad to scroll to second page of MENU.
4. Press number "3" keypad to activate "Enter MW Only".
  - Oven will now be in Microwave Only Mode.
  - "Enter MW Only" item on MENU screen will change to "Exit MW Only".
5. To exit MENU: Press STOP/RESET keypad.
  - READY: MW ONLY screen is displayed.

### Exit MW-Only Mode

Press POWER ON/OFF (⏻) keypad to exit microwave-only mode and begin preheating the oven. WARMING UP screen displays. READY screen will display once oven reaches the specified preheat temperature.

### Manual Cook in MW-Only Mode

1. Oven must be in MW-Only Mode first. See "Enter MW-Only Mode".
2. Complete steps in "Manual Cooking" on page 11.
  - Oven Temperature will read "MW ONLY" and will not be an editable field.

### Operating Preset Recipe Keypads in MW-Only Mode

This oven can store up to 10 preset "MW-Only" recipes in memory.

1. Oven must be in MW-Only Mode first. See "Enter MW-Only Mode".
2. Complete steps in "Operating Preset Recipe Keypads" on page 12.

### Edit Recipe in MW-Only Mode

This oven can be programmed to store up to 10 preset "MW-Only" recipes in memory.

1. Oven must be in MW-Only Mode first. See "Enter MW-Only Mode".
2. Complete steps in "Edit or Create New Recipes" on page 14.
  - Oven Temperature will read "MW ONLY" and will not be an editable field.

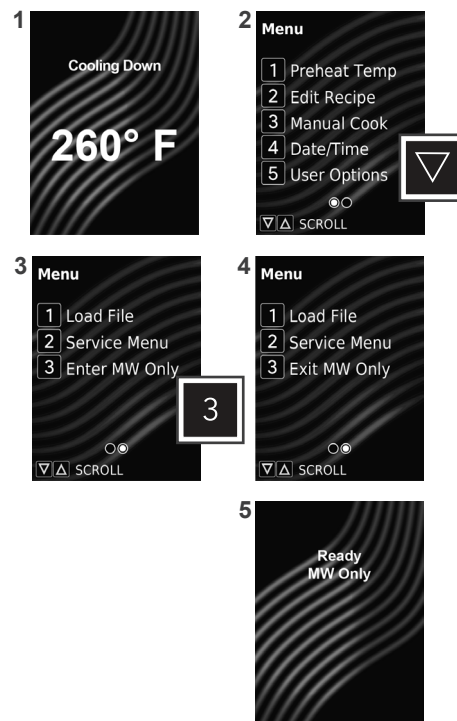

## 1 Import Menu from USB Flash Drive

**Note:** Menu file must be .XML format. Menu file must be saved at the root directory of the flash drive, and cannot be located inside any folders.

1. Flip open USB port protective cover. Insert flash drive into the USB port.
2. Press MENU (≡) keypad.
  - If prompted, enter PIN Code and press START/OK keypad.
  - MENU screen will display.
3. Press DOWN (▼) keypad to scroll to second page of MENU.
4. Press number "1" keypad to access "Load File".
  - LOAD FILE screen displays with list of .XML files on the root directory of the flash drive, and an option to "Export to USB".
  - If more than 4 recipes files are on the flash drive: Press UP/DOWN (▲▼) keypads to scroll through pages of files.
5. To load a file: Press corresponding number keypad.
  - If upload was successful: "Loaded OK" will display. Settings and menu items will be loaded on the oven.
  - If upload failed: "Error Loading" will display.
6. Press STOP/RESET keypad to exit. Remove USB Flash Drive.

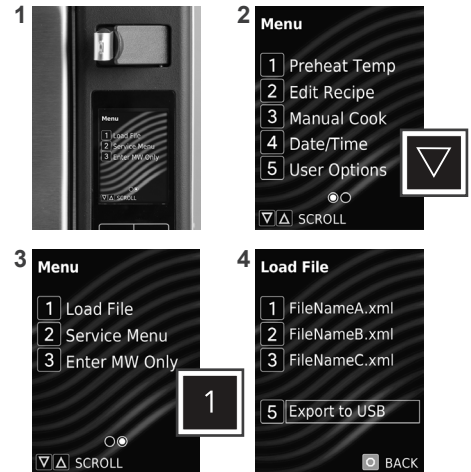

### TROUBLESHOOTING:

USB flash drive must be inserted prior to selecting "Load File."

- Press STOP/RESET keypad to exit LOAD FILE screen. Insert flash drive and retry transfer.
  - ↳ If the error persists: Open USB flash drive on computer and verify that menu file is in .XML format and saved in the root directory of the flash drive. Retry transfer.
  - ↳ If the error persists: Unplug oven from outlet and plug-in oven. Retry transfer.

## 5 Export Menu to USB Flash Drive

1. Flip open USB port protective cover. Insert flash drive into the USB port.
2. Press MENU (≡) keypad.
  - If prompted, enter PIN Code and press START/OK keypad.
  - MENU screen will display.
3. Press DOWN (▼) keypad to scroll to second page of MENU.
4. Press number "1" keypad to access "Load File".
  - LOAD FILE screen displays with list of .XML files on the root directory of the flash drive, and an option to "Export to USB".
5. Press number "5" keypad to access "Export to USB". Oven will begin to export to USB flash drive.
  - If export was successful: "Export OK" will display. Settings, menu items, and oven usage data will be loaded on USB Flash Drive.
  - If export failed: "Export Failed" will display.
6. Press STOP/RESET keypad to exit. Remove USB Flash Drive.

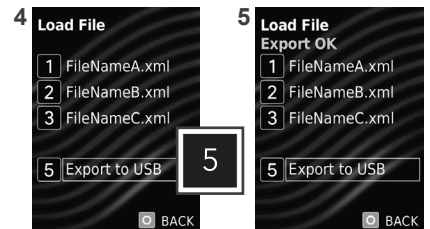

### TROUBLESHOOTING:

USB flash drive must be inserted prior to selecting "Export to USB."

- Insert flash drive and retry transfer.

## ACP Programming Application



For larger, and more complex menus, it may be more manageable to create and edit menus using the ACP Programming Application. For detailed instructions, please visit: [www.acpsolutions.com/oven-programming/](http://www.acpsolutions.com/oven-programming/)

### OPEN MENU IN ACP PROGRAMMING APPLICATION

**Note:** For more details, please see ACP Programming Application User Guide online

1. Insert flash drive into USB port on computer.
2. Open ACP Programming Application.
3. Select "File", "Open." Navigate to flash drive. Select and open menu file (.XML format).

## Update Firmware

**Note:** Firmware files must be loaded on USB flash drive. Must be saved at the root directory of the flash drive, and cannot be located inside any folders.

1. Flip open USB port protective cover. Insert flash drive into the USB port.
2. Press MENU (≡) keypad.
3. Press DOWN (▼) keypad to scroll to second page of MENU.
4. Press number "2" keypad to access "Service Menu".
  - PIN Code prompt appears.
5. Press keypads 1-3-5-7-9 to enter SERVICE MENU.
6. Press and hold number "7" keypad for 3 seconds to initiate firmware update.

### TROUBLESHOOTING:

If firmware fails to load: Press and hold STOP/RESET keypad while plugging in the oven.

# STYLE 1 User Options

There are several options you can change to customize the operation of the oven. Options are shown below. The **factory setting is shown in bold type**.

## 5 Access and Modify User Options

- Press MENU (≡) keypad.
  - If prompted, enter PIN Code and press START/OK keypad.
  - MENU screen will display.
- Press number "5" keypad to access "User Options".
  - USER OPTIONS screen will display with list of customizable settings.
  - To scroll between pages of settings: Press UP/DOWN (▲ ▼) keypads.
- To access available options for a setting: Press corresponding number keypad.
  - The currently selected option is highlighted in red.
- To change a setting: Press corresponding number keypad.
  - The newly selected option is highlighted in red.
- To save changes:** START/OK keypad.
- To exit:** Press STOP/RESET keypad.

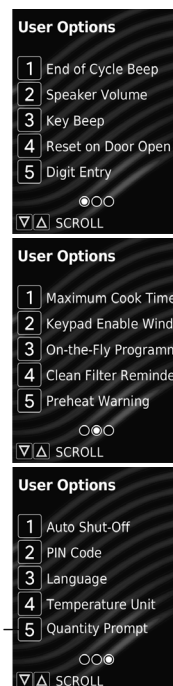

### STANDARD DEFAULT PER MODEL (FACTORY SETTINGS IN BOLD)

Factory setting may vary by model

SETTING	DISPLAYED OPTIONS	DESCRIPTION
End of Cycle Beep	<b>3 Seconds</b> Continuous Burst	<b>3 second continuous beep</b> Continuous beep until door is opened 5 beep bursts until door is open
Speaker Volume	Off Low <b>Medium</b> High	Sets volume to off Sets volume to low <b>Sets volume to medium</b> Sets volume to high
Key Beep	Off <b>On</b>	Prevents beep when keypad is pressed <b>Allows beep when keypad is pressed</b>
Reset on Door Open	End Cook Cycle <b>Pause Cook Cycle</b>	Cancels heating time count down after door is opened during cycle. <b>Allows oven to resume heating time countdown after door is opened during cycle</b>
Digit Entry	<b>Single Digit</b> Double Digit Folders	<b>Allows 10 (0-9) preprogrammed recipes</b> Allows 100 (00-99) preprogrammed recipes Allows 10 folders (0-9), each with 10 preprogrammed recipes
Maximum Cook Time	10 minutes <b>20 minutes</b>	Allows 10 minutes of heating time <b>Allows 20 minutes of heating time</b>
Keypad Enable Window	15 seconds 30 seconds <b>1 minute</b> 2 minutes	15 seconds after oven door is opened, keyboard disabled 30 seconds after oven door is opened, keyboard disabled <b>1 minute after oven door is opened, keyboard disabled</b> 2 minutes after oven door is opened, keyboard disabled
On-the-Fly Programming	Off <b>On</b>	Disables pushing any additional keypads during a cook cycle <b>Allows pushing additional keypads to add or change time in the middle of a cook cycle</b>
Clean Filter Reminder	Off <b>Every 7 Days</b> Every 30 Days Every 90 Days	Oven will not display "Clean Filter Message" <b>Oven will display "Clean Filter Message" every 7 days</b> Oven will display "Clean Filter Message" every 30 days Oven will display "Clean Filter Message" every 90 days
Preheat Warning	Enabled <b>Disabled</b>	Oven will display warning message if recipe temperature does not match oven temperature <b>Oven will not display temperature warning message</b>
Auto Shut-Off	Never <b>2 Hours</b> 4 Hours 8 Hours	Oven will not automatically shut-off <b>After 2 hours of inactivity, oven will automatically shut-off</b> After 4 hours of inactivity, oven will automatically shut-off After 8 hours of inactivity, oven will automatically shut-off
PIN Code	<b>Off</b> On Set PIN Code	<b>PIN Code not required to access Menu or User Options</b> PIN Code required to access Menu and User Options PIN Code required. Create new 4 digit PIN Code
Language	Chinese (Mandarin), Danish, Dutch, <b>English</b> , Filipino, French, German, Greek, Italian, Japanese, Korean, Norwegian, Polish, Portuguese, Romanian, Russian, Spanish, Swedish, Ukrainian, Vietnamese	
Temperature Unit	Fahrenheit Celsius	Temperatures are displayed in Fahrenheit for 60Hz models Temperatures are displayed in Celsius for 50Hz models
Quantity Prompt**	On <b>Off</b>	Prompts the user for portion quantity multiplier (1-9) upon selecting a preset recipe <b>Allows user to cook individual portions</b>

\*\* Available on select models only. (Only displayed in User Options menu if factory option is enabled)

*Note: There are multiple styles of controls. Choose the control that matches unit. Control panel branding and coloring may vary by model*

## Oven Features

- (1) **TOP CONTROL PANEL**
- (2) **DISPLAY**
- (3) **SIDE CONTROL PANEL**
- (4) **AIR INTAKE FILTER (not pictured)**  
Removable/cleanable magnetic air filter
- (5) **DOOR HANDLE**  
Ergonomically designed for one handed "Lift and Pull" operation.
- (6) **USB PORT (not pictured)**  
Standard USB flash drive compatible. Allows for import/export of programmed settings and user options.
- (7) **OVEN RACK (not pictured)**  
The oven is equipped with a removable stainless steel oven rack. 2 available installation positions.
- (8) **UNIT SERIAL NUMBER (not pictured)**  
Located inside the door and on the back of the oven.

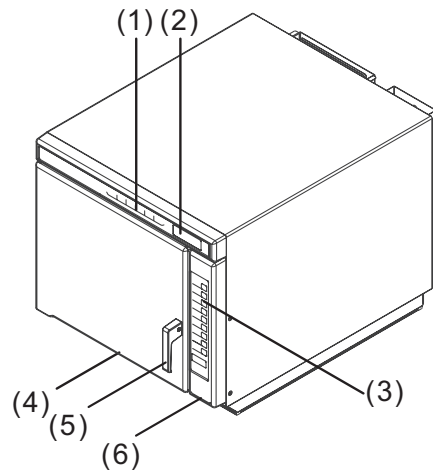

## Control Panel Features

### TOP CONTROL PANEL

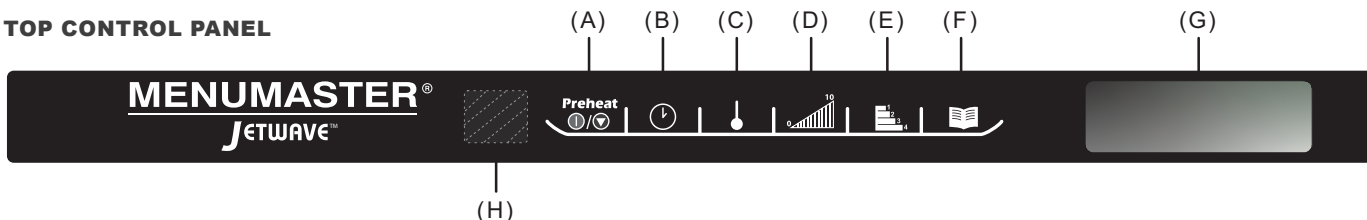

- (A) **PREHEAT ON/OFF KEYPAD**  
Preheats oven. Begins cool-down process.
- (B) **TIME ENTRY KEYPAD**  
Use to enter cooking time for either manual entry or programming modes.
- (C) **TEMPERATURE ENTRY KEYPAD**  
Use to enter oven temperature.
- (D) **POWER LEVEL KEYPAD**  
Use to set microwave power level between 0% to 100% in 10% increments (keypad "0" = 0%, keypad "1"=10%, keypad "2"=20%,etc.). For 100% power level, press any number keypad twice.
- (E) **STAGE KEYPAD**  
Use in manual cooking and/or programming modes to add additional cooking stages. Up to four stages can be entered.
- (F) **PROGRAM SAVE KEYPAD**  
Use to access, create, edit, and save settings for preset cooking programs; oven preheat temperature; and user options.
- (G) **DISPLAY**  
LED-backlit LCD.
- (H) **HIDDEN KEYPAD**  
Use to access user options.

- (I) **NUMBER KEYPADS**  
Used to operate preset cooking programs and enter settings.
- (J) **STOP/RESET KEYPAD**  
Interrupts a cooking sequence in progress; clears out any remaining time; and also ends a programming or user option cycle. When the Stop/Reset pad is used to end a programming or option change, the changes are discarded.
- (K) **START/OK KEYPAD**  
Begins cooking in Manual Time Entry Mode. Restarts an interrupted cooking cycle. Used to save settings and entries.

### SIDE CONTROL PANEL

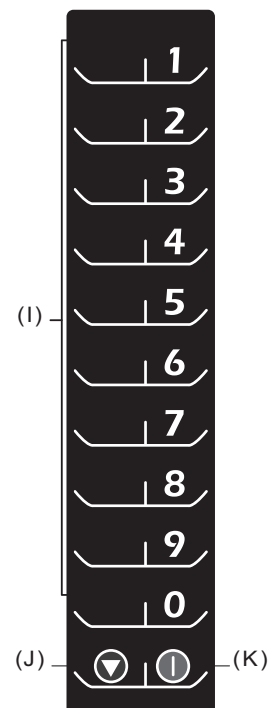

## Cooking Energies and Options

<b>CONVECTION ENERGY</b>		<b>MICROWAVE ENERGY</b>	
<p>Convection cooking utilizes both a convection element and fan to evenly distribute heated air throughout the oven cavity. The circulating air surrounds food in an envelope of evenly heated air. Consistent temperatures cook food evenly and reduce cooking time. By default, convection power is enabled. While enabled, oven will maintain a minimum convection temperature of 150°F (65°C) to ensure drier air and more even cooking.</p>		<p>Microwave cooking uses high frequency energy waves to heat the food. When cooking, microwave energy causes food molecules to move rapidly. This rapid movement between the food molecules creates heat, which cooks the food. Oven generates microwave energy while cooking screen countdowns and displays power level greater than 0%.</p>	
<b>Convection-Only Cooking</b>	<b>Combination Cooking Convection with Microwave</b>	<b>Microwave-Only Cooking</b>	
<p>To operate with convection-only, use cook settings with 0% microwave power level.</p>	<p>The combination of both energies uses the speed of microwave energy and browning of convection cooking to yield high quality food faster. To operate with combination cooking, set convection temperature between 150°F (65°C) – 475°F (250°C). and set microwave power level between 10 – 100%.</p>	<p>Microwave-Only mode allows operator to disable convection power and cook using only microwave energy. To operate with microwave-only, see "Microwave-Only Manual Operation" and "Microwave-Only Preset Keypad Operation" on page 22 .</p>	

## Programming Features

### STAGE COOKING

Allows operator to use up to four different cooking cycles or stages consecutively without repeated input from the operator. For example, stage cooking can be set to defrost food initially, then cook it, and then finish with more toasting/browning.

### PRESET PROGRAM KEYPADS (DIGIT ENTRY)

The oven can store either 10 or 100 cooking programs in memory.

#### A. Single Digit Keypad Cooking

From the factory, the oven is programmed to store 10 cooking programs (0-9). Each keypad begins a cooking program.

#### B. Double Digit Keypad Cooking

The oven control can be changed to store up to 100 cooking programs (00-99). Each entry will be assigned a double digit number, for example 01, 05, or 20. When using the double keypad programming, two keypads must be pressed to start the cooking cycle.

**Note:** To set control to Double Digit Entry, see "User Options" section in this manual.

## Methods of Cooking & Programming

### COOKING WITH PRESET PROGRAM KEYPADS

Allows operator to quickly activate saved cooking sequences using 1-2 keypad strokes

### MANUAL COOKING

Allows operator to heat without changing the preset program keypads

### MANUAL PROGRAMMING MODE

Allows operator to use keypads to edit preset programs and/or create new programs for customized cooking.

### USB MENU UPLOAD

Allows operator to load program settings and user options using a standard USB flash drive

### ACP PROGRAMMING APPLICATION

Allows operator to create and edit program settings and user options on a computer.

For detailed instructions, please visit: [www.acpsolutions.com/oven-programming](http://www.acpsolutions.com/oven-programming)

## Cooking Displays

STYLE 2	DESCRIPTION
STANDBY OR PRESS PREHEAT	"STANDBY" displays when oven is turned off; after the oven is plugged in, the door is opened, and then shut.
OVEN PREHEATING 475°F	"Oven Preheating 475°F or 250°C" displays when oven is turned on and is warming up to the selected preheat temperature. <b>Oven Preheating</b> also flashes when a cooking sequence can be started or programmed.
READY 475°F	"Ready 475°F or 250°C" displays when oven has reached preheat temperature and is ready to cook. <b>Ready</b> also flashes when a cooking sequence can be started or programmed. <i>Note: Oven will shutdown after two hours of inactivity.</i>
00:00	Displays cooking time. If stage cooking is programmed, total cooking time is displayed.
MW 50%	"MW __%" displays the current microwave power level. 100% is the highest setting, and 0% is lowest (no microwave energy used).
ITEM-05	"ITEM-__" displays the single or double digit entry location of a programmed cooking sequence when using a programmed pad.
STAGE 1	"STAGE _" displays the stage number (1 through 4) the oven is at in the cooking sequence.

## Programming Displays

STYLE 2	DESCRIPTION
ENTER PROGRAM TO ADD/REVIEW:	Displays when oven is in programming mode.
STAGE 1	Displays stage number during cooking or when programming a specific cooking stage. Stage number (1 through 4) indicates the stage that is being used.

## USB Display

STYLE 2	DESCRIPTION
USB	Displays when keypad 5 is pressed and held, and transfer to/from USB flash drive is ready.

## Example Cooking Displays

MANUAL	STAGE:1
00:15 475°F	MW:100%

### MANUAL COOKING

ITEM-05	STAGE:1
01:23 475°F	MW:50%

### PREPROGRAMMED ITEM

ITEM-05	STAGE:1
01:23	MW:50%

### PREPROGRAMMED ITEM IN MICROWAVE-ONLY MODE

## Preheat Warnings

The combination oven has two optional temperature warnings. Warnings sound with a three beep signal when a programmed recipe keypad is pressed. Available warnings include:

- A warning when the preheat temperature does not match the preprogrammed temperature of a cooking sequence.
- A warning when the actual oven cavity temperature is not to preheat temperature, such as when the oven is first started.

To override the warning and begin a cooking cycle: Press START/OK keypad.

**Note:** To change Preheat Temperature Warnings, see "User Options" section in this manual.



## Power-On, Preheat

Press PREHEAT ON/OFF keypad to begin preheating. OVEN PREHEATING screen displays. READY screen will display once oven reaches the specified preheat temperature.

## Edit Oven Preheat Temperature

This oven can be set to a preheat temperature between 150°– 475°F (65°– 250°C). It is recommended to set to the most commonly used temperature for the oven. Factory default setting is 475°F (250°C).

1. Press PROGRAM SAVE keypad.
2. Press TEMPERATURE ENTRY keypad
3. Press number keypads to enter desired preheat temperature.
  - Temperature must be entered in 5°F (5°C) increments. If not, the temperature will automatically change to the nearest 5°F (5°C).
4. Preheat temperature is changed.

## Manual Cooking Mode

Allows operator to heat without changing the preset program keypads.

**Note:** Oven must be preheated before combination or convection cooking.

From READY or DOOR OPEN screen:

1. Open oven door, place food in oven, and close door.
  - "READY" will display.
2. **To enter Cooking Time:** Press TIME ENTRY keypad.
  - Press number keypads to enter cook time.
3. **To edit Cooking Temperature:** Press TEMPERATURE ENTRY keypad.
  - Press number keypads to enter desired cooking temperature.
4. **To edit Microwave Power Level:** Press POWER LEVEL keypad.
  - Press number keypads to enter % microwave power ("0"=0%, "1"=10%, "2"=20%, etc.). For 100% microwave power level, press any number keypad twice.
  - **For Convection-Only cooking:** Press "0" keypad to set 0% MW power.
5. **To add additional cooking stages:** Press STAGE keypad.
  - Repeat steps 2, 4, and 5 for each additional stage.
  - Up to four stages can be entered.
6. Press START/OK keypad to begin cooking.
  - Oven operates and display counts down cooking time.
7. At the end of the cooking cycle, the oven beeps. Oven interior and cooking dish will be hot. Carefully remove food from oven.

## MICROWAVE-ONLY MANUAL OPERATION

**Note:** Microwave Only must first be enabled in User Options> Microwave Only.

Allows operator to heat using only microwave energy, and without changing the preset program keypads.

- Enable Microwave Only user option. See "User Option" section in this manual for instructions.
- After User Option>Microwave Only is enabled, complete steps 1–2 and 4–7 in "Manual Cooking Mode" section.

## Operating Preset Program Keypads

To heat using a preset program, press number keypad(s). Oven will start to heat automatically.

**Note:** Oven must be preheated before combination or convection cooking.

From READY or DOOR OPEN screen:

1. Open oven door and place food in oven. Close door.
  - "READY" will display.
2. Select the keypad(s) for the desired preprogrammed cooking sequence.
  - **Single Digit Keypad Cooking:** Press a keypad (0-9)
  - **Double Digit Keypad Cooking:** Press two keypads, in order, of the double digit number for the desired cooking sequence.(00-99)
3. Oven begins cooking and displays preset cooking program, total cooking time, cooking temperature, percentage of microwave power, and stage.
4. At the end of the cooking cycle, the oven beeps. Oven interior and cooking dish will be hot. Carefully remove food from oven.

## MICROWAVE-ONLY PRESET KEYPAD OPERATION

**Note:** Microwave Only must first be enabled in User Options> Microwave Only.

Allows operator to heat using only microwave energy and using preset program keypads.

- Enable Microwave Only user option. See "User Option" section in this manual for instructions.
- After User Option>Microwave Only is enabled, complete steps 1-4 in "Operating Preset Program Keypads" section.



## Programming Mode

Allows operator to assign cook times, power levels, and stage cooking to the number keypads. From READY or DOOR OPEN screen:

1. Press PROGRAM SAVE keypad.
  - Programming mode begins.
  - "Enter Program to Add/Review:" will display.
2. Select the keypad(s) to change or review the program cooking sequence.
  - **Single Digit Keypad Cooking:** Press a keypad (0-9).
  - **Double Digit Keypad Cooking:** Press two keypads, in order, of the double digit number for the desired cooking sequence (00-99).
3. **To enter Cooking Time:** Press TIME ENTRY keypad.
  - Press number keypads to enter cook time.
4. **To edit Cooking Temperature:** Press TEMPERATURE ENTRY keypad.
  - Press number keypads to enter desired cooking temperature.
5. **To edit Microwave Power Level:** Press POWER LEVEL keypad.
  - Press number keypads to enter % microwave power ("0"=0%, "1"=10%, "2"=20%, etc.). For 100% microwave power level, press any number keypad twice.
  - **For Convection-Only cooking:** Press "0" keypad to set 0% MW power
6. **To add additional cooking stages:** Press STAGE keypad.
  - Repeat steps 3, 5, and 6 for each additional stage.
  - Up to four stages can be entered.
7. **To save the cooking program:** Press PROGRAM SAVE keypad.
8. **To discard changes:** Press STOP/RESET keypad.

## USB Programming

Allows operator to import or export program settings and user options using a standard USB flash drive.

Oven must be in Standby mode (Preheat must be OFF) .

1. Remove protective USB cover from bottom of vertical keypad.
2. Insert flash drive into the USB port, located below the vertical keypad.
3. Open oven door.
4. Press and hold number "5" keypad until "USB" appears in the display.
  - a. **To Import Menu from USB flash drive to Oven:**
    - Press number "1" keypad.
    - "USB TO OVEN" will display.
  - b. **To Export Menu from Oven to USB flash drive:**
    - Press number "2" keypad.
    - "OVEN TO USB" will display.
5. Press START/OK keypad to begin transfer.
  - "LOADING" will display for approximately 10 seconds.
  - "DONE" will display and oven will beep once transfer is complete.
6. Press STOP/RESET keypad to exit. Remove USB Flash Drive.

### TROUBLESHOOTING / ERROR CODES:

- **NO USB:** Remove flash drive from USB and reinsert flash drive into USB. Retry transfer.
- **RESET OVEN:** Unplug oven from outlet and plug-in oven. Retry transfer.



USB Port located below control panel

There are several options you can change to customize the operation of the oven. Options are shown below. The **factory setting is shown in bold type**.

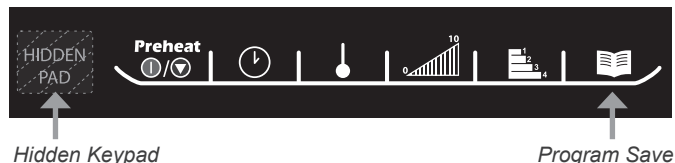

## Access and Modify User Options

From READY or DOOR OPEN screen:

1. Press hidden keypad.
  - Hidden keypad is unmarked and located to the direct left of Preheat On/Off keypad.
  - Nothing will be displayed when hidden keypad is pressed.
2. Press PROGRAM SAVE keypad.
  - The first user option will display. Oven is now in options mode.
3. Press number keypad that corresponds to setting.
  - See table below for keypads/settings/options.
  - Setting and the currently selected option will display.
4. Press numeric keypad again to toggle through list of options for the keypad/setting.
  - Each time keypad is pressed, the displayed option will change.
  - Changes take affect after keypad is pressed.
  - Press PROGRAM SAVE keypad to save changes.
5. Press STOP/RESET keypad to exit, or open and close oven door.

### STANDARD DEFAULT PER MODEL (FACTORY SETTINGS IN BOLD)

*Factory setting may vary by model*

KEYPAD	SETTING	DISPLAYED OPTIONS	DESCRIPTION
<b>1</b>	Double Digit Entry	Disabled Enabled	<b>Allows 10 (0-9) preprogrammed pads.</b> Allows 100 (00-99) preprogrammed pads.
<b>2</b>	Manual Time Entry	Disabled <b>Enabled</b>	Manual time entry/cooking not allowed <b>Manual time entry/cooking allowed</b>
<b>3</b>	Reset on Door Open	Disabled Enabled	<b>Opening oven door does not reset oven back to ready mode.</b> Opening oven door does resets oven back to ready mode.
<b>4</b>	Keybeep	<b>Keybeep On</b> Keybeep Off	<b>Keys beep when pressed</b> Keys do not beep when pressed
<b>5</b>	Keybeep Volume	Off Low Medium <b>High</b>	Keybeep volume OFF. Keybeep volume LOW. Keybeep volume MEDIUM. <b>Keybeep volume HIGH.</b>
<b>6</b>	End of Cook Signal	Solid Beep <b>3 Second Beep</b> 4 Beeps Once 4 Beeps Repeating	Food done signal is a continuous beep until reset by user. <b>Food done signal is a three second beep.</b> Food done signal is four beeps, once. Food done signal is four beeps, four times.
<b>7</b>	Keypad Active	15 seconds 30 seconds <b>60 seconds</b> 120 seconds Always	Keypad time entry window is 15 seconds. Keypad time entry window is 30 seconds. <b>Keypad time entry window is one minute.</b> Keypad time entry window is two minutes. Keypad time entry window is always active.
<b>8</b>	Preheat Warnings	Disabled Program Warning Only Preheat Warning Only Both	<b>Both temperature warnings off.</b> Warning only when preheat temperature does not match preprogrammed temperature Warning only when actual oven cavity temperature is not to preheat temperature. Both temperature warnings on.
<b>TEMPERATURE ENTRY KEYPAD</b>	Temperature Scale	Fahrenheit Celsius	Temperatures are displayed in °Fahrenheit for 60Hz models. Temperatures are displayed in °Celsius for 50Hz models.
<b>STAGE KEYPAD</b>	Clean Filter Message Frequency	Disabled <b>Weekly</b> Monthly Quarterly	Oven will not display "Clean Filter Message" <b>Oven will display "Clean Filter Message" every seven (7) days.</b> Oven will display "Clean Filter Message" every thirty (30) days. Oven will display "Clean Filter Message" every ninety (90) days.
<b>POWER LEVEL KEYPAD</b>	Microwave Only	Disabled Enabled	<b>Oven will not operate in "Microwave Only" mode.</b> Oven will operate in "Microwave Only" mode.

*\*Factory setting may vary by model*

# Care & Cleaning

Convection and microwave energies are attracted to any food source in the oven. Moisture, spills, and grease can affect heating performance and may cause oven damage. To prevent damage to oven, clean oven frequently and remove any food debris. Follow the recommendations below.

**⚠ CAUTION: NOT FOLLOWING APPROVED OVEN CLEANING INSTRUCTIONS MAY VOID YOUR OVEN WARRANTY.**

**⚠** Do NOT use abrasive cleaners or cleaners containing ammonia, citrus, phosphates, chlorine, sodium or potassium hydroxide (lye). The use of caustic cleaning products or those containing ammonia, citrus, phosphates, chlorine, sodium or potassium hydroxide (lye) can damage critical oven parts. Use of unapproved cleaning agents will void the terms of warranty.

**⚠** Do NOT use water pressure type cleaning systems.

**⚠** ALWAYS unplug oven before cleaning.

## RECOMMENDED CLEANING SUPPLIES:

Damp towel, plastic scouring pad, ACP Oven Cleaner (Item CL10 (US), Item CL10W (EU)), ACP Oven Shield Oven Protectant (Item SH10 (US), Item PR10W (EU)), mild liquid dishwashing detergent, rubber gloves, safety glasses, microfiber cloth.

## FOR A NEW OVEN, BEFORE USING IT FOR THE FIRST TIME:

When oven is clean, spray damp towel with ACP Oven Shield Protectant and wipe all interior surfaces. Do not remove ACP Oven Shield Protectant. Turn oven on and preheat to start cooking.

## ⚠ WARNING

To avoid electrical shock which can cause severe personal injury or death, unplug power cord or open circuit breaker to oven before cleaning.

To prevent burns, handle utensils, rack, accessories, and door with care. Allow oven, utensils, rack, and accessories to cool before cleaning. Oven, utensils, and accessories become hot during operation.

Wear protective gloves and protective glasses when cleaning the oven.

Failure to maintain the oven in a clean condition could lead to deterioration of the surface that could adversely affect the life of the appliance and possibly result in a hazardous situation.

## Daily Care and Cleaning

### PREPARE OVEN

1. Press Power ON/OFF keypad to power-off oven. The fan will run to cool the oven interior faster. Allow oven to cool down to 200°F (95°C) (Approximately 10–15 minutes with the door open and 45–60 minutes with the door closed).
2. Once cooled, carefully remove oven rack and other accessories from the cavity.

### CLEAN OVEN RACK AND ACCESSORIES

3. Clean the oven rack with liquid dishwashing detergent such as Dawn®, and a non-abrasive sponge or soft bristle brush. Allow to air-dry.
4. For other accessories, please refer to instructions included in original packaging.

### CLEAN OVEN INTERIOR

5. Remove baked-on particles using a plastic scouring pad.
6. **APPLY OVEN CLEANER:**
  - ⚠** Do NOT spray cleaning solution directly onto back-wall perforations.
    - a. Spray oven inner door, sides, and floor with ACP Oven Cleaner. Allow to soak 2–5 minutes.
    - b. Spray damp towel with ACP Oven Cleaner and wipe oven inner back-wall.
7. **CLEAN AND WIPE OVEN INTERIOR:** Wipe the oven interior using a damp clean towel. Rinse towel and wring dry. Repeat 2–3 times to remove remaining cleaner and debris.
8. **APPLY OVEN SHIELD:** When oven is clean, spray damp towel with ACP Oven Shield Protectant and wipe all interior surfaces. Do not remove ACP Oven Shield Protectant.
9. Reinstall oven rack in oven.

### CLEAN OVEN EXTERIOR

10. **CLEAN EXTERIOR DOOR AND SURFACES** with a clean cloth, sponge or nylon pad; using a mild detergent and warm water solution.
11. **CLEAN CONTROL PAD AND SCREEN** with a dry or damp microfiber cloth.
  - ⚠** Do NOT use Windex or other harsh chemicals. Do NOT spray liquid on the screen.

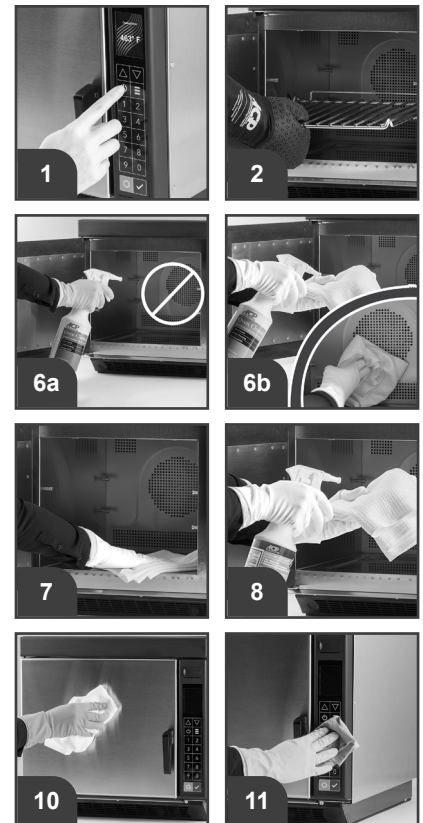

## Weekly Cleaning

### CLEAN AIR FILTER

Air filter is located below oven door.

- A. **FOR OVENS WITH NON-REMOVABLE AIR FILTER:**  
Wipe louvers using a damp clean towel.
- B. **FOR OVENS WITH MAGNETIC/REMOVABLE AIR FILTER:**  
Remove magnetic air filter. Wash filter in a mild detergent solution made with warm water. Rinse and dry thoroughly. Reinstall filter on the oven base.
  - ↳ For STYLE 1 ovens with AF10 accessory, see image B-1.
  - ↳ For STYLE 2 ovens, see image B-2

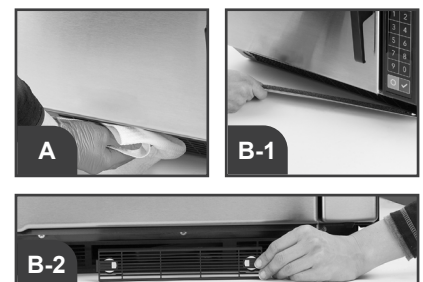

# Before Calling for Service

Record all inspections and repair for future reference.

## ⚠ WARNING

To avoid electrical shock which can cause severe personal injury or death, do not remove outer case at any time. Only an authorized servicer should remove outer case.

This is a Class A product. In a domestic environment this product may cause radio interference in which case the user may be required to take adequate measures.

OVEN STYLE	SYMPTOM	POSSIBLE CAUSE
All	Oven fan turns on while oven is not preheating or cooking.	Normal operation
	Oven does not operate	Confirm oven is plugged in. Check fuse or circuit breaker. Confirm oven is plugged into dedicated circuit. Confirm oven is on grounded and polarized circuit. Contact electrician to confirm.
	"CLEAN FILTER" shows in display.	This is normal and will appear for 24 hours. • Complete steps to "Clean Air Filter" on page 25. • To clear the message, Press START/OK keypad.
	If oven does not accept entries when keypad is pressed	Make sure oven is on and preheated. Open and close oven door. Press keypad again. Check User Option>Digit Entry.
Style 1	"EXCEEDS MAXIMUM COOK TIME" shows in display.	Total cook time exceeds the maximum allowable. • Check cook times per stage. • Check User Option>Maximum Cook Time.
	"INVALID ENTRY" shows in display.	PIN Code entered is incorrect, or cook time is zero or unset. • Correct entry. Retry.
	"OVEN HOT!" shows in display.	Cavity temperature exceeded the limit. • Wait for 30 minutes for cavity to cool down. ↳ If error continues to show in display: Unplug oven, wait for 1 minute. Plug-in oven. ↳ If the error persists, please call for service.
	"ERROR 7: RTD OUT OF RANGE" shows in display.	RTD was exposed to momentary spike. • Unplug oven, wait for 1 minute. Plug-in oven. ↳ If the error persists, please call for service.
	"ERROR 5: STUCK KEY" shows in display.	A keypad is actuated continuously or there is an issue with the keypad. • Ensure the keypad is not in contact with anything. ↳ If the error persists, please call for service.
Style 2	Oven operates intermittently or "HOT" shows in display.	Check air filter and discharge areas for obstructions.
	If oven malfunctions or shows: <b>ERROR!</b> <b>ERROR CODE: 1</b> (example)	Oven control is equipped with a self-diagnostic system. Self-diagnostic system alerts you if there is an error or problem. When electronic control signals a problem, follow steps listed below. • Record number shown. (Example: "Error Code: 1") • Unplug oven, wait for 1 minute. Plug-in oven. ↳ If code does not reappear, continue with normal use of the oven. ↳ If the error persists, please call for service. Do not use oven until contacting the ACP Servicer.

**24/7 ComServ Contact:**



**866-426-2621**

email: [commercialservice@acpsolutions.com](mailto:commercialservice@acpsolutions.com)

For full product documentation visit:  
[www.acpsolutions.com](http://www.acpsolutions.com)